

...

1-36

3

«

»

—

1966



• •

’ ’ ’
,

IX— III .

3 — « »

1 9 6 6

• •

1

4 5

» «

« » , 6

»¹ «

47 754 IX—XIII 7

2 1911 1913₆ 18. X—XIII 1946₇ 3 195 6

» «

3 754 219 X—XI

1 1, 1908, 45—46.

2 « », « », « »

3 MAP, 18, 1895, 63.

4 MAP, 18, 1896, 34. MAP, 20, (. 65, 1959, 130)



« » , « »
 .
 -
 ,
 ,
 .

1863 . , —
 ».⁸

« » —
 (, ,
 . .).

(. 1).⁹

8 . III . , 1901,
 . 78.

IX—X .
 I—III, V—VII .
 IV IVA 6
 XI . « »
 IV.

¹⁰ . Ellehaug e . The Spear traced through its post-Roman development. Tøjhusmuseets Skrif- ter 5, Copenhagen, 1948.

, ,
 , ,
 , ,
 , ,
 VI .

.¹¹ VI—VII .

».¹² VI—VIII . (IX .)

13
 ,
 14
 , 15
 16
 17

IX X .
 I
 (. 2).
 X .

¹¹L. Niederle. Slovanské starožitnosti, díl III, sv. 2, Praha, 1925, . 547.

1903 . 200.

¹³ 3 . 1950 .











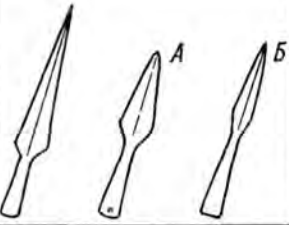
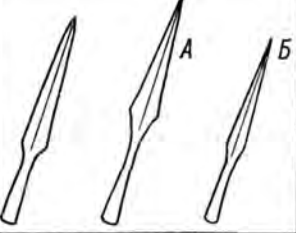
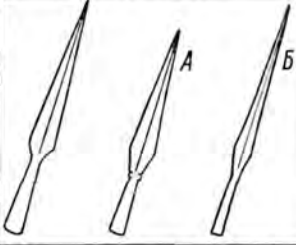

¹⁴ . 1977; 1697, 1441.

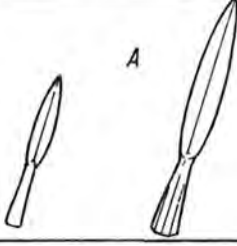
¹⁵ , 6, 1941, . IX, 7.

1951 . 74—77, . 27. . 52, 1953,
¹⁶3 VIII—IX .

. (. . . . 8, , 1959,
¹⁷ II, . 3 4 . 43).

IX—X .
 VIII—IX .

дата типы	IX - нач. XI вв.	XI - XII вв.	XII - XIII вв.
I			
II			
III			
IV			
V			
VI			
VII			

1. IX—XIII

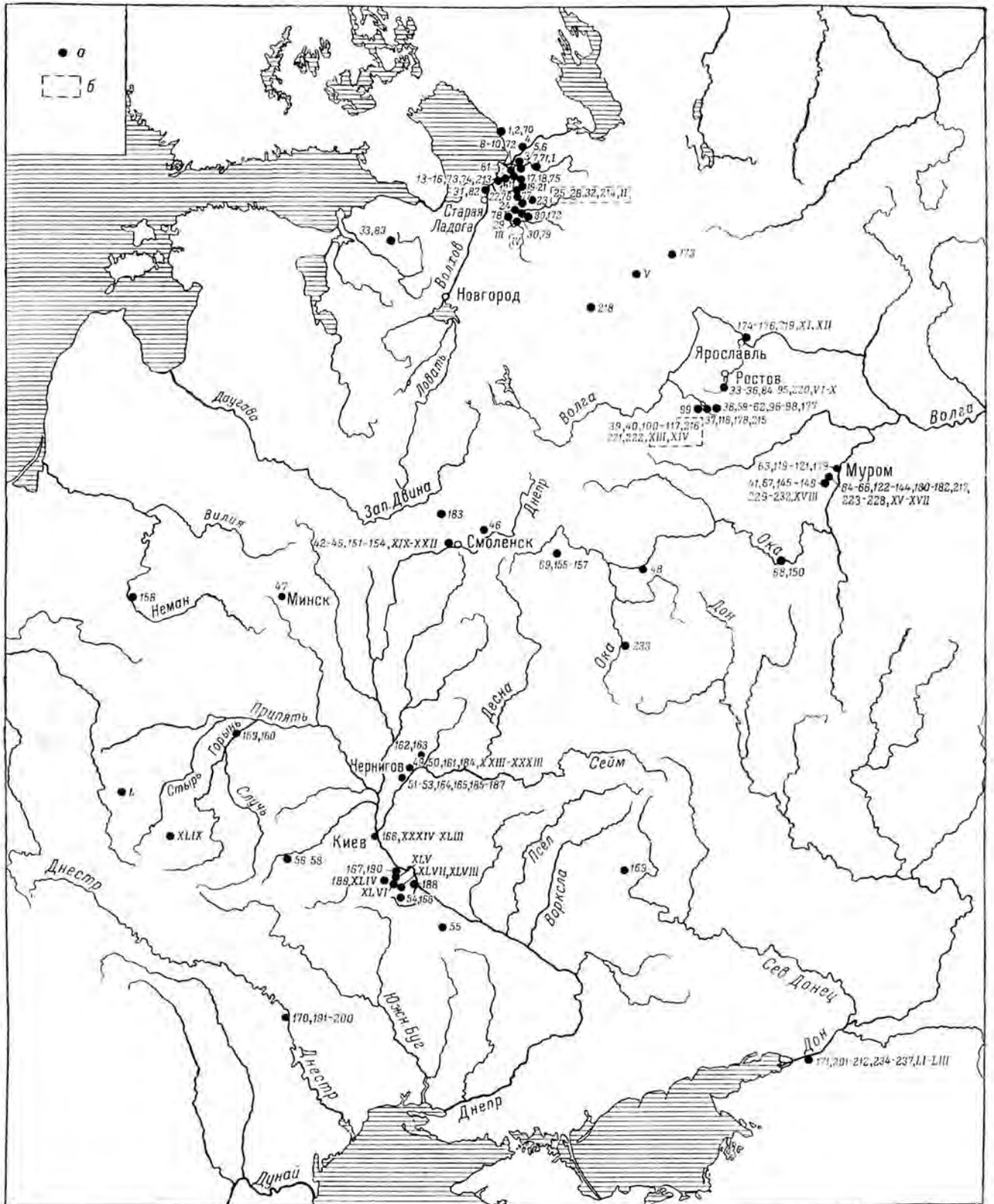

. 2. IX — XI .

1—237, 1—LIII — ; — ; —

XI

I.

(. 3).

22

(. 15, 1—2; 16, 1—3; 17, 1, 3—4; 19, 1—2; 20, 3-4; 21, 1-4, 25, 3-4 7).

X .)

(.) .

XII—XIII

12 VIII—IX .

(. 4).

3 X—XI .

243; . 15, 2 20, 4),

(18, 47

IX—X . (.) . 24

X .

XI

900—1050 .

25

VII—VIII

26

22 . 1—58 238—262 — 83 .
: 25—40 ,

2. 5—3 . 0. 5—0. 7 .

23 J. ak. Eino skandinavische frühmittelalterliche Eisenlanzenspitze aus Grosspolen. Meddelanden fran Lunds universitets historiska museum. Lund, 1959. 139.

24 H. r b m a n . Schweden und das karolingische Reich. Stockholm, 1937, . 234. — (.) .

145 (J. ak. Eine skandinavische frühmittelalterliche Eisenlanzenspitze..., . 140—148). — 1958 .

25 J. ak. Eine skandinavische frühmittelalterliche Eisenlanzenspitze..., . 138.

26 ö h n e r . Die fränkischen Altertümer des Trierer Landes. Berlin, 1958, Bd. 1, . 152—153; Bd. 2, . 28, 1 29, 5; G. Gjessing . Studier i norsk Merovingertid. Skrifter utgitt av det norske

18

14) 19 . I—IV, (. : 1871—1887, . 55, 2, 3, 10

20 11, 1949, . 22.

— ., 1958, . 303; . : . .

21 . . . XI, 1958, . 144. (

1229 1231 .) .

1071

1123 . (. .

. 723).

, . II. ., 1902,

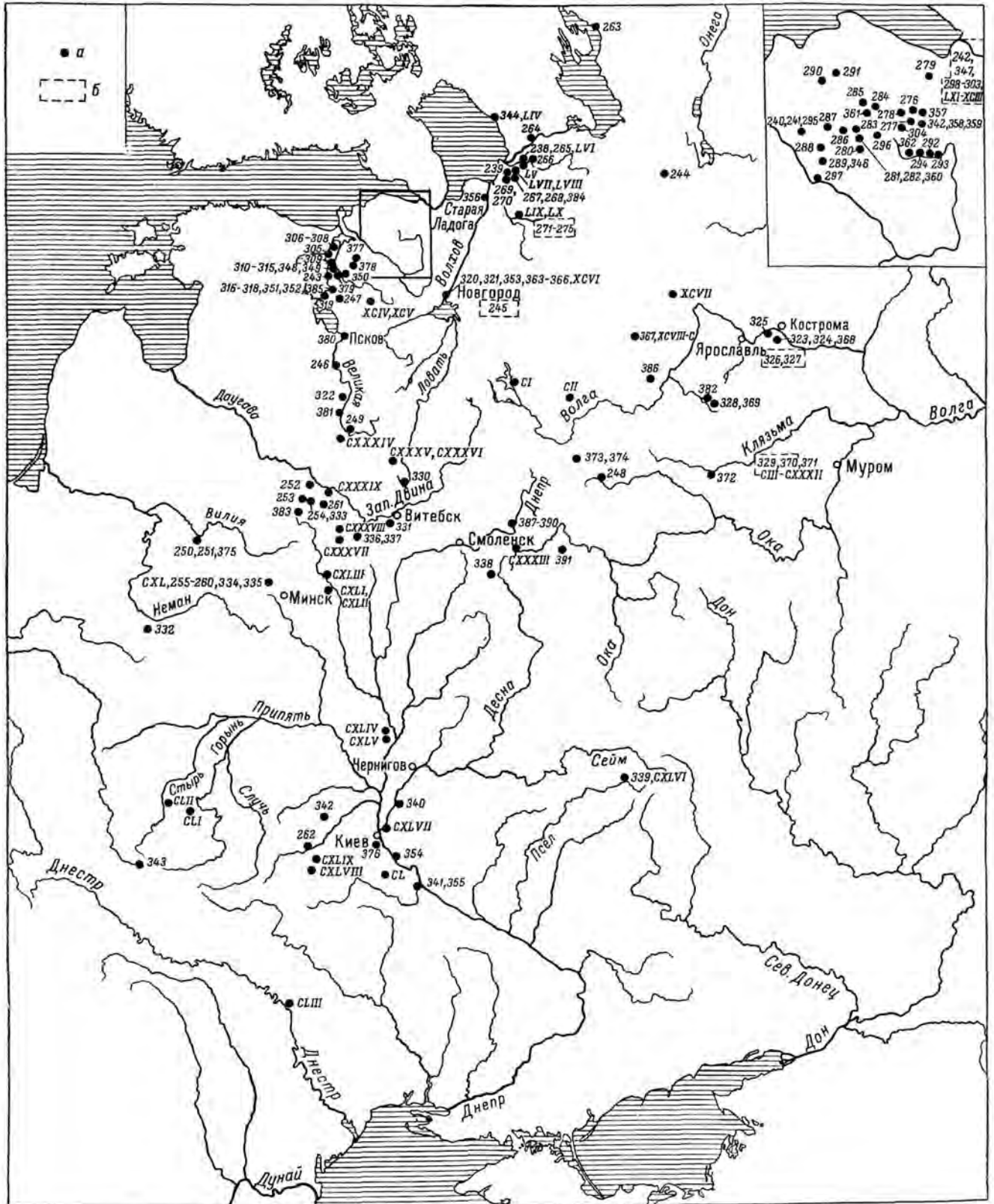

3. XI—XII

238—391, LIV—LIII —

2.

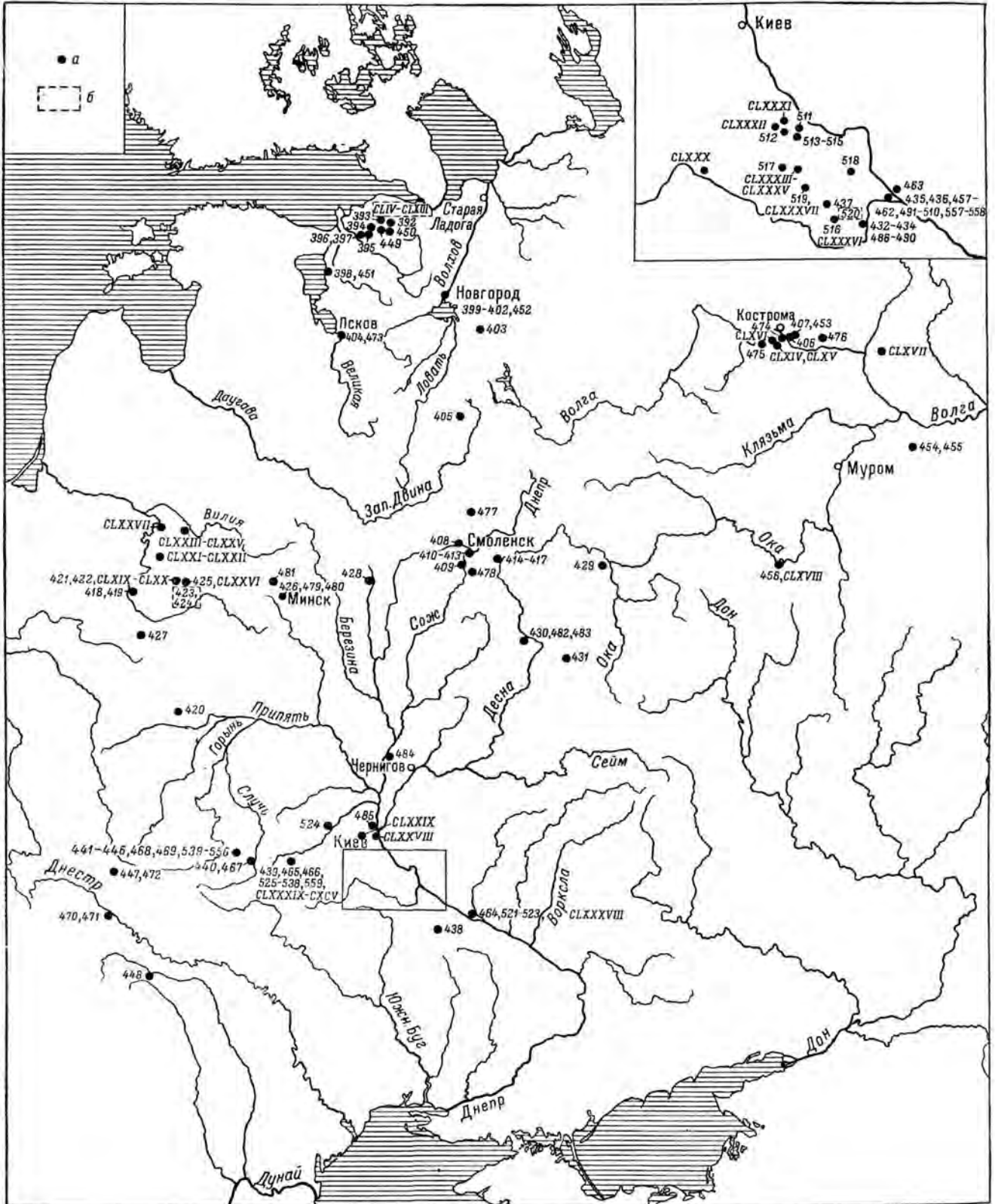

27

VIII—IX

(45, 1891),

32

33

34

VII—VIII

1000

III.

35

28

II.

29 (. 21, 5—7).

(. 16, 4—6; 17, 6, 7; 18, 2, 3, 8, 9; 19, 4, 8, 9, 13; 20, 1; 21, 8-14; 36, 2; 37, 1 6).

IX—XI 30

36

X — XI

(VIII—XI),

X

zeit in Finnland. SMYA, XLII, Helsinki, 1930, XXXVI, 5, . 190 .;

VI—VIII 31

X , . I, M., 1899,

Videnskaps-Akademi i Oslo, II Hist.-filos. klasse, N 2. Oslo, 1934, . 59—60; F. Fremersdorf. Das fränkische Reihengräberfeld Köln-Müngersdorf. Berlin, 1955, Tafelband, . 98, 1—7.

II, 4 IV, I, 5.

27 J. Petersen. De norske vikingesverd. Kristiania, 1919, . 26, . 12; 13 (E); M. Ellehaug. The Spear..., . 33; 34; 35; E. Gessler. Die Trutzwaffen der Karolingerzeit vom VIII bis zum XI Jahrhundert. Basel, 1908, . 48 (

32 XVIII, 7, 16 28. — VIII—IX

IX XI .)

28 J. Petersen. De norske vikingesverd, . 26; E. Elvén. Die Eisenzeit Finnlands, II, Helsinki, 1951, . 17 . 797.

33 IX—XV 1, . — ., 1947, . 78;

29 : . 59—69 — 11 . 3 ,

32, 1953, . 109 . 140 (, , ,

30 : . 30 , . 155—160°.

34):

31 VIII—XI 1952, . XXX, I.

34 ra. Die Eisenzeit in Lettland bis etwa 500 n. Chr., Teil II. Tartu, 1938, . 195, (); Ausgrabungen und Funde, Bd. 3, Heft 4/5, Berlin, 1958, p. 71.

1957, . 63, . V, 2: . öhner. Die fränkische Altertümer..., Bd. I, . 148; Bd. II, . 28, 3; H. Salmo. Die Waffen der Merowinger-

35 70—75 ., 263—264 ., 402

— 112 . 50 , 3—5 .

20—40 , 3 . 130—140°, 1 .

150°. 2: 1, 3: 1,

3: 2; 3: 6

III.

(78, 80 333)
 F
 G ()
 G). (F
 IX—X
 XI
 XII-XIII
 39
 III
 (80, 86—89, 152,
 333; 35, 6).
 40
 37 J. Petersen. De norske vikingesverd,
 15 17; 18. — F 850—
 950 G — X — XI
 38 J. Eisner. Devínska Nová Ves. Bratislava,
 1952, 290, 47, 5; 61, 7; 72, 1; 108, 11.
 39 III XII—XIII
 (50),
 40
 VIII
 Die Waffen..., 163 173, (II. S 1 m
 47; 48).

(, 332)
 X (, 340; . 20, 1) —
 42
 XI . ,
 III
 IX . (IIIA),
 I—4; 35, 5). 43 1: 1; . 18, 4; 22,
 III (X .) III
 IX — XI
 ()
 VIII—IX 44 45
 III XI—
 XIII IX—X
 41 . Strömb rg. Eine silbertauschierte wi-
 kingerzeitlicher Speerspitze in einer schonischen Pri-
 vatsammlung. wiatowit, t. XXIV, Warszawa, 1962,
 409—420, . 1; 2; 3.
 42 J. rne. Gotland-Kiev under vikingatiden.
 Gotlandskt Arkiv. Lund, 1943, . 1 . 11. —
 1000
 43 , 76, 90—93
 III IX — XI . 56 . 3. 5—5
 20—25 , 1—1.5
 3 145—155°.
 44 . . MAP, 10,
 .. 1893, . X, 8, 30 33;
 . 39/57 39/59 ; .
 45 . . XXIX, . — .
 « 1949, . 14, 5 . 78; .
 . , 62, 1958, . 16 . 123.

XI

III A

X

(. 19, 5—7, 10; 22, 5—7).

8-13).⁵⁶ III (. 17, 2 9; 18, 1; 22,

X—XI

150

(. . III III).

III

III

267, 280, 291, 312, 329, 341)

(265,

(408)

(⁴⁹ ,⁴⁷ ,⁴⁸ ,⁵⁰ ,⁵¹ ,⁵² ,⁵³).

XI

III).

XII—XIII

XIII XIV . (401)

IV.

18, 14; 20, 2; 23, 1, 2; 36, 8;⁵⁷ (. 17, 5; 37, 8).

⁵⁴

IV

XIII .⁵⁵

XI . (, XII .).

⁴⁶ III A XI—XIII . 265, 267 . 31

38—45 , 27—35 ,
1 , 3. 8—5 ,
2—3. 5. 155° .
2: 1 3: 1.

⁵⁶ , 94—95, 136, 140, 146, 281—282 . —

(XII—XIII 58—64);
3 (XII—XIII 1. 5—2),
2. 5—3 , 0. 6—

⁴⁷London museum catalogues, N 1, London and Vikings. London, 1927, puc. 12, 5.

⁴⁸M. Ellehaug. The Spear..., . 31.

⁴⁹J. Petersen. De norske vikingesverd, . 25.

⁵⁰E. Kivikoski. Die Eisenzeit Finnlands, t. II, . 18, . 807; 808.

⁵¹Nermann. Die Verbindungen zwischen Skandinavien und dem Oslbaltikum. Stockholm, 1929, . 113—116, . 105 113; R. Hausmann. Katalog der Ausstellung zum X archäologischen Kongress in Riga 1896. Riga, 1896, . 23, 9; . MAP, 14, . 1893, . XIV, 8.

⁵²A. Nadolski. Studia nad uzbrojeniem polskim w X, XI, i XII wieku. Łódź, 1954, . XX.

XIII—XI . XXXI, 5.

⁵⁴E. Kivikoski. Die Eisenzeit Finnlands, t. II, . 40, . 1104; 1105.

0. 8 . 160° .
2: 1, 3: 1.

III XII—XIII

(394, 396, 404, 410—413, 414—416, 426, 430, 446).

⁵⁷ , 344—355 — 12 (25—27),
19—30 (2—2. 5 ;

3—4 0. 7
1: 1 2: 1.

⁵⁸W. M. Flinders-Petrie. Tools and Weapons, London, 1917, . XXXVII, 1—15.

⁵⁹G. Gjessing. Studier i norsk Merovingertid, . 43—45; H. Salmo. Die Waffen..., . 176, 207—209, . XXXIII, 3 . 49 . 240;

..., . II, 2; IV, 2, 3.

. XXXVIII, . 1951, . 23, 11 . 50; .
., 1961, . 174, . 68.

XI .
 60
 1100 .⁶²
 (351; . 47, 4).
 , 354; . 20, 2)⁶³
 XII .
 (IVA).
 64 (. 16, 7 23, 3—4).
 5, 6).
 (700—1000 ,
 200—400),
 XVII .⁶⁶ (.) , XV—

⁶⁰W. Gaerte. Urgeschichte Ostpreußens. Königsberg, 1929, . 275, ; . Norman. Die Verbindungen..., . 103, J. R. Aspelin. Antiquitates du Nord Finno-Ougren. Helsinki, 1877—1884, . 1959; 2011; E. Kivikoski. Die Eisenzeit Filmlands, t. II, . 17, . 802; 803.

⁶¹M. Erbert. Zu den Beziehungen der Ostseeprovinzen mit Skandinavien in der ersten Hälfte des XI Jahrhunderts. In: Baltische Studien. Berlin, 1914, . 133—137, . 5 . 127.

⁶². Ellehauge. The Spear..., . 30, . 61; 62.

⁶³. J. Arne. Gotland-Kiev..., . 2

⁶⁴. , 449—472 — 24 .

XII .
 (I IV);

⁶⁵ , 452, 455, 458, 466, 467, 469, 470 —
 7 . : 40—50 ,

25—30 , 5—6 .

4—5⁶⁶ , 1.5 .
 , . 29 .

67
 1149 .,
 1255' .
 « . ».⁶⁸
 XVI .
 69
 « »
 70
 V.
 10—13 23, 7—13). (. 18,
 (X — XI .).
 71
 XVI .⁷² ,
 73
 6

⁶⁷ III A
 6 (401 444)
 47—64 (416, 433 437).

⁶⁸ 1255 .
⁶⁹ 1887 . XXXV, 6 XXXVI, 22.

⁷⁰A. Brückner. Słownik etymologiczny języka polskiego. Kraków, 1927, . 528.
⁷¹ , 172—212, 356—376 473—556 —
 146 . : 15—
 30 , 3 . 1. 5 ,
 3: 2.

⁷² . , . , 1953, . 38.
⁷³ . 18.

VIII—IX⁷⁴
⁷⁵

(510).

IX—XI⁷⁹

1),
(3. 5),

(⁸⁰ ⁸¹),

« XIV ».

X⁸²

XVII⁸³

(⁸²). X
« »

(XI).
X—XI

« (, — . .) XIV

XVII . «

XIII

XII—

«⁸⁵ (, — . .)
».

XII

XII— III

⁷⁴J. Eisner. Devínska Nová Ves., 372,
⁷⁵96, 2 45, 9.

. XLI, 1951, 99, 30, I 36.

82 77 24. XXXVI, —, 1951, 2,

XII

1911—1912, 56, 1914,
³⁰ 148.

115⁷⁹, 42, 7 117. LVII, 1955,

XII⁸⁶

XII—XIII⁸⁷

MAP, 26, 1902, XXVII, 10

14; 52, 1953, 87, 35, 94;

XII—

VIII—XI, XXXV, 2, 4, 5, XXXVIII, 7, 11;
B.

80 118. LXV, 1956, 38, 3

⁸³ XX, 1948, 7,

⁸⁴ Abu ben Abderahman ben H deil.
La parure des cavaliers. Paris, 1924, 243.

C. 1958, XXI, I, 104.

⁸⁶ 1647, 1904, 108.

⁸¹J. Hamel. Alterthümer des frühen Mit-
⁸²telalters im Ungarn, Bd. I. Braunschweig, 1905, 446.

⁸⁷ 11 h a u g e . The Spear..., 30.
29 54; 55 (

188. 75, —, 1959, 186

. XV .). — (: N
d lski. Studia..., XIX, 4 5).

XIII ⁸⁸ , X—XI .

VI.

(. 18, 5; 24, 1, 2; 36, 4).

III (IV).⁸⁹

X—XI .

(- ,)

).

VIII—IX ⁵⁰⁰ ⁹⁰
X—XIII ⁹¹

XI

VII.

(. 24, 3—6).

)⁹²

XI

(I)

(V)

(III).

⁸⁸London museum catalogues, 7, London, 1954,

XVI, 1—4, 73.

⁸⁹XVI, 213—217 377—383 — 12 .

VI 35 ,

3—5 .

VI

(332),

« »

⁹⁰R. Hausman. Katalog der Ausstellung..., 23, 12 15; 11gr n. Zur Archäolo-

gie Eestis. Dorpat, 1925, 126 160; i-

vik ski. Die Eisenzeit im Auralflussgebiet, SMYA,

t. XLIII, Helsinki, 1939, 216, XXXVII, 4;

1957,

27—28 X, 2; S l m . Die Waffen...,

246, VI, 5.

⁹¹XIV, 9 XIV, 11; 15/42, 15/17 . —

XII—XIII

(⁹²), 218—237, 384—391 557—559 —

31

XI

X

⁹³Nad lski. Studia..., 56

XXIX, ⁹⁴5 6.

, 1958, 43, 1; VIII—XI

XXXVIII, 8 10; X, 5

11; XXVII, 6.

⁹⁵S l m . Die Waffen..., 255

54; 55; 56; 11 h a u g e . The Spear..., 21; 22.

IX — XI . ()

Район или место находки	Типы									Всего
	①	II	III	IIIА	IIIБ	V	VI	VII	неявленные	
Южная Карелия	2	—	1	—	—	—	—	—	—	3
Юго-Восточное Приладожье	30	—	11	1	—	1	2	—	4	49
Западная часть Ленинградской обл. (Озёр- тицы)	1	—	1	—	—	—	—	—	—	2
Вологодская обл. (Луковец)	—	—	—	—	—	1	—	—	—	1
Калининская обл.	—	—	—	—	—	—	—	1	1	2
Ярославская обл. (Сарское, Михайловское)	3	—	6	4	2	3	—	2	7	27
Суздальское Ополье	4	4	1	21	1	2	2	2	2	39
Муромщина	1	5	3	25	3	4	1	10	4	56
Смоленская обл.	5	—	3	1	—	1	—	—	4	14
Старая Рязань	—	1	—	1	—	—	—	—	—	2
Калужская обл.	1	1	3	—	—	—	—	—	—	5
Тульская обл. (Федяшево)	—	—	—	—	—	—	—	1	—	1
Минск (окрестности)	1	—	—	—	—	—	—	—	—	1
Гродно	—	—	1	—	—	—	—	—	—	1
Брестская обл. (Хотомель)	—	—	—	2	—	—	—	—	—	2
Чернигов и окрестности	5	—	5	—	—	4	—	—	11	25
Киев и область	4	—	1	—	—	1	—	—	10	16
Киевское Поросье	1	—	2	—	—	2	—	—	5	10
Харьковская обл. (Карачевка)	—	—	1	—	—	—	—	—	—	1
Вольнь	—	—	—	—	—	—	—	—	2	2
Молдавия (Екимауцы)	—	—	—	1	—	10	—	—	—	11
Ростовская обл. (Цимлянская)	—	—	1	—	—	12	—	4	3	20
Итого	58	11	40	56	6	41	5	20	53	290

III, V). (I, III .

X . X . (

XI . X .

(III) XI . IX — 20 XI .

(III, IIIA III) 96 7

(I), (III) — , 4 (

(II, VI, VII),

96 : 1 2; 7 71; 8, 9 72; 268 384; 13 14; 17 75; 19 20; 80 172; 33 83; 120 121; 122 123; 130 224; 254 333; 50 161; 56—58. —

XI—XII . ()

Район или место находки	Типы									Всего
	I	III	IIIА	IIIБ	IV	V	VI	VII	неизвестен	
Южная Карелия	—	1	—	—	1	—	—	—	1	3
Юго-Восточное Приладожье	2	8	4	—	—	1	—	1	6	22
Западная часть Ленинградской обл. и Гдовщина	4	32	8	4	8	6	3	1	35	101
Вологодская обл. (Киснема)	1	—	—	—	—	—	—	—	—	1
Новгородская обл.	1	1	1	—	1	4	—	—	1	9
Псков и область	2	1	—	—	—	—	2	—	—	5
Калининская обл.	—	—	—	—	—	1	—	1	6	8
Костромская обл.	—	4	1	—	—	1	—	—	—	6
Суздальское Ополье	—	—	2	—	—	3	1	—	30	36
Московская обл.	1	—	—	—	—	1	—	—	—	2
Смоленская обл.	—	—	—	—	—	2	—	4	1	7
Северо-западная Белоруссия (бывш. Виленская и Витебская губ.)	6	4	—	—	—	1	1	—	6	18
Центральная и южная Белоруссия (Минская, Могилевская и Гомельская области)	7	4	—	—	—	—	—	—	6	17
Калужская обл. (Мощины)	—	1	—	—	—	—	—	1	—	2
Курская обл. (Гочево)	—	—	1	—	—	—	—	—	1	2
Черниговская обл.	—	1	—	—	1	—	—	—	—	2
Киев и область	1	1	1	—	1	1	—	—	3	8
Киевское Поросье	—	—	—	—	—	—	—	—	1	1
Волынь и Подоллия	—	—	—	—	—	—	—	—	3	3
Львовская обл. (Подгорцы)	—	1	—	—	—	—	—	—	—	1
Итого	25	59	18	4	12	21	7	8	100	254

XI—XII . -

III
IV.

97

XI—XII .

IX—X .

(. 2). XI .

(II). XI .

(I VI)
(IV

III).

(IV),

(III).

(I, III, V).

ХII—ХIII . ()

Район или место находки	Типы							Всего
	III	IIIА	IIIБ	IVА	V	VII	неизвестен	
Западная часть Ленинградской обл. и Гдовщина	—	2	5	3	—	—	10	20
Новгород и область	1	4	—	1	—	—	—	6
Псков	—	—	1	—	1	—	—	2
Калининская обл. (Торопец)	—	—	1	—	—	—	—	1
Костромская обл.	2	—	—	1	3	—	4	10
Смоленская обл.	2	—	8	—	2	—	—	12
Старая Рязань	—	—	—	1	—	—	1	2
Горьковская обл. (Малое Терюшево)	—	—	—	2	—	—	—	2
Северная и западная Белоруссия (бывш. Виленская и Витебская губ., Гродно, Дрогичин, Друцк, Волковыск)	1	5	4	—	—	—	9	19
Минск и область	—	—	1	—	3	—	—	4
Калужская обл. (Спас-Перекша)	1	—	—	—	—	—	—	1
Брянская обл. (Вшиж)	—	—	1	—	2	—	—	3
Орловская обл. (Карачев)	—	—	1	—	—	—	—	1
Черниговская обл. (Любеч)	—	—	—	—	1	—	—	1
Киевская обл.*	—	—	1	—	1	—	2	4
Сахновка и Княжа Гора	1	1	3	6	26	2	—	39
Киевское Поросье	—	—	1	—	9	—	8	18
Полтавская обл.	—	—	—	2	3	—	1	6
Житомирская обл.	1	—	1	3	15	1	7	28
Хмельницкая обл. (Городище)	3	1	2	2	18	—	—	26
Львовская обл. (Звенигород)	1	—	—	1	—	—	—	2
Ивано-Франковская обл. (Крылоє)	—	—	—	2	—	—	—	2
Черновицкая обл. (Ленковцы)	—	—	1	—	—	—	—	1
Итого	13	13	31	24	84	3	42	240

*

98
ХII—ХIII

(. 3).
 X ., (V), III), 2. 5 , XII—XIII
 150 (III)
 2—2. 5) .
 (. 4 5).
 V), (I, III, IIIA, III — 469
 82%
 XI ., (IVA), XII—
 XIII

IX—XIII . ()

Дата	Типы											Всего
	I	II	III	IIIА	IIIБ	IV	IVА	V	VI	VII	неизвестен	
IX—начало XI в.	58	11	40	56	6	—	—	41	5	20	53	290
XI—XII вв.	25*	—	59	18	4	12	—	21	7*	8	100	254
XII—XIII вв.	—	—	13	13	31	—	24	84	—	3	42	210
Итого	83	11	112	87	41	12	24	146	12	31	195	754

* XI .

Формы лезвия	Типы	Количество
Ланцетовидная	I	83
Ромбовидная	II	11
Удлиненно-треугольная	III, IIIА, IIIБ, VI	252
Удлиненно-яйцевидная	IV	12
Лавровидная	IVА	24
Пиковидная	V	146
Двушильная	VII	31

99
 (VI),
 X . (III),
 XI . (IV).
 III, IIIА, IV, VI
 XI—XII
 IVA, V VII
 III, III ,
 (VII)
 (IV).
 (II,
 III, IIIА, IV, VI).
 99 X .
 « »

« »

100

()

XVI : «

(, — . .)

1149 « »¹⁰⁷

« »

101' »

108

1229

109

« » « » « »

102 »

III¹¹⁰

XVI . . : «

»¹⁰³ »¹¹¹ ()

104 : « » « » « »

112

113

XII—XIII

9 , 90 : «¹⁰⁵»

XIV¹⁰⁶

100 .: A. Bruhn-Hoffmeyer. *Midde-*
laldereus tveaeggede svaerd, t. I. København, 1954,
 202

101 1149 .¹⁰⁷

102 1151 1184 .¹⁰⁸

1905¹⁰³ 137. . 1, 1890, . 81. . 8 . 12 .

104 ., 1908, . 84. . XIX, 1948, . 67. 1175 .

18. . 112 .

105 1169 . , 1960, 4, . 35.

106 ., . III, M., 1939, . 195. 113 69.

». ¹¹⁴

(60-100 .). ¹¹⁶

47

XI—XIII

(8).

(. 6;

. 5).

(. 17, 8; 18, 6, 7; 20, 5; 24, 7—13; 36, 5).

ТА 6

X—XIII . ()

Район или место находки	Типы				Всего
	II	III	IVA	незавесен	
Юго-Восточное Приладожье	—	2	1	—	3
Западная часть Ленинградской обл. и Гдовщина	—	5	2	—	7
Вологодская обл. (Киснема)	—	1	—	—	1
Новгород и обл.	1	4	1	—	6
Калининская обл. (Сырогой)	—	1	—	—	1
Костромская обл.	—	—	1	—	1
Суздальское Ополье	—	2	—	—	2
Муромщина	1	1	—	—	2
Московская обл. (Тушково)	—	1	—	—	1
Смоленская обл.	—	3	1	—	4
Витебская обл. (Браслав и Друцк)	—	3	—	—	3
Гродно и Новогрудок	2	1	—	—	3
Минск и Заславль	—	3	—	—	3
Курская обл. (Гочево)	—	—	1	2	3
Калужская обл. (Мощины)	—	2	—	—	2
Чернигов	—	—	—	2	2
Киев	—	—	—	1	1
Вольнь (Старое Жуково)	—	—	—	1	1
Полтавская обл. (Воинская Гребля)	1	—	—	—	1
Итого	5	29	7	6	47

115

114

115 . 112.

, 1950, . 92.

(.), 8—12 ^{15—20},
1. 5—2,
2. 5—3. 5 .

2. 1 . ¹¹⁷ 1. 2—1. 5 , (.) 6 1. 8—
35

(. 0. 4) 3 ,

(1. 5—2. 5) .

¹¹⁸

¹²⁰

« ».

XIII

(« »),

(« »),

(1216) .

¹¹⁶

¹¹⁷ 65, 1959, . 128.

. 34.

¹¹⁸ 1, 2, 10, 17, 18, 21, 24, 26, 36,

39—40, II, III IVA.

¹¹⁹ 11 haug e. The Spear..., . 26—

27; . Miller. Historische Waffen. Berlin, 1957,

⁶⁵

¹²⁰ H.

. 298, 301, 303-304.

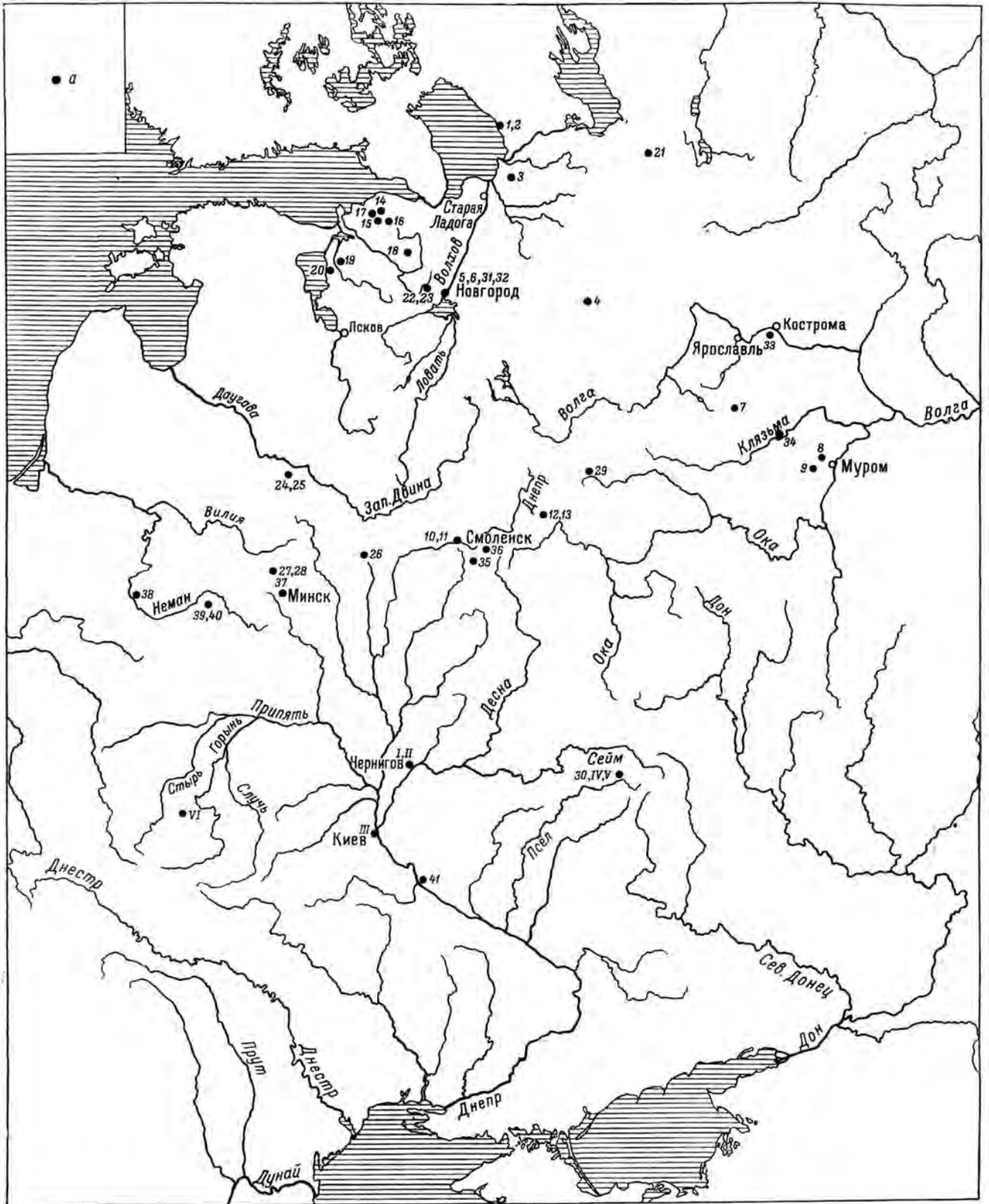

1-41, I-VI —

5. X—XIII

2.

: «

», ¹²¹

┌

┌
123

XVII—XVIII

XVII

¹²⁴

», ¹²²

X—XII

«

XIII

¹²³

617;

, III, 1912, 615—

¹²¹
¹²²

1216

¹²⁴ . Ellehaug. The Spear..., 74
.48;49;50;51;52;53;
. — , 1932, 106, 136.

XVII . , 1895, . 1, . 71.

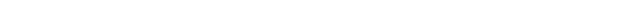

2

i ...

XII .

1
 «
 »,
 2
 «
 3
 —
 4
 ».
 5
 1
 2 MAP, 18, 1895, 62
 3 1896, 34—35. MAP, 20,
 103; 32, 1956, 39
 4 MAP, 29, 1903, 37—38.
 5 IX—XV
 1, —, 1947, 87.

6
 7
 8
 XIII . X.
 XI—8
 524
 X. 12
 X.
 X.
 « » « »
 6 XI, 1915, 222
 7 88.
 8 X. XI—XII , 1960. 1, 70—90.



. X. , , ,

. X.

. X.

(),
(),

().

. X.

9

(, ,), . X.

(, , , 3, , ,
()).

. X.

. X.

10

. X.

11

« »

15

VIII 16

I

17

12 P. Pauls n. Axt und Kreuz in Nord und Osteuropa. Bonn, 1956.

13 , . 16.
14 , . 145.
15

1/10

16 j j , j , 1957,
95. j j ,

17 , . X , 1899, . V, 134, 136;

74, 1958, . LXXXIX; . I . . .

, 72, 1959, . 24, 4—5 25, 11.

(. . . 1956 .).

9 , , (: . X. XI—XII
1, 33 44), (: 1, 38 35),
10 (: 1, 37, 40—42).
11 1, 37 2, 4; XI—XII , 1, 38 2, 6;
1, 40—42 2, 1, 5, 10.
1, 25; 1, 31;
1, 31; (22), 1, 31;
(33), 1, 32

4. 5 , 600—800 .

IX—X .

X .

X—XIII .,

1600 .,

(1130 .),

9—12),

()

».¹⁸

« »

¹⁹

(²⁰ 80),

()

12

(9—15 ,

2—3¹⁰—

450 .

».²³

200—350).

²⁴

« »

».²⁵

: 15—22 (17—18),
9—14. 5 , 3—

²¹

« »

¹⁸

⁴².

¹⁹

XI—XIII .

²²⁰, 240—241).

²²

921—922 .

²,²⁰ . X. , 1957, . 196—197.

²³ , 1957, . 141.

XI—XII ., . 77. —

²⁴ ., 1908, . 79.

();

²⁴ 1138 . 1180 ¹⁰¹⁴ 1229 .; ¹¹⁴⁴ .

²⁵

. — ., 1958, . 299.

10%
760

(72

7

²⁶

²⁷

²⁸

²⁹

15%
494).³⁰

(78

13

(5

),

³¹

²⁶

(X—XIII 443—447).

²⁷P. Paulsen. Axt und Kreuz..., . 33—34.

²⁸ . . V, . . X
; 1902, . . II . IV.

²⁹ XVII . . 1, . . 1859, . . 75; . . Me

³⁰ , 1958, . . 1, . . 288.

³¹

23

X—XIII

1.

2.

3.

573

(79

).³²

(. 6).³³

8

(

(

IV, V

VI).

(Bartaxt),

(I—III,

— IV—VIII.

(. 7; 8; 9).

³²
XIII — 494 (, 1600 X—
79 ((, — 760 ((?) —







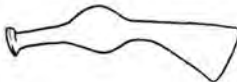

³³

(?)

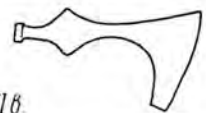
— 210 (

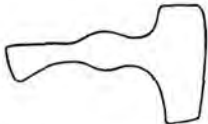
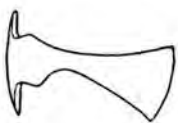
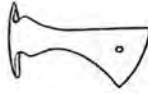
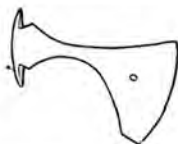
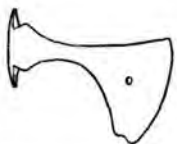
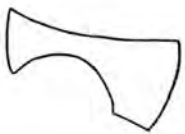
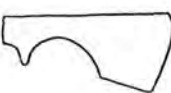
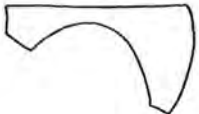
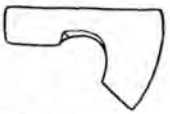
2 (

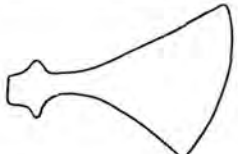
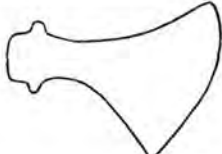
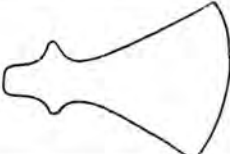
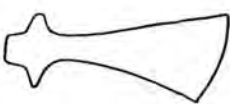
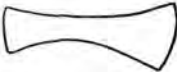
),

дата типы	X-нач. XI вв	XI-XII вв	XII-XIII вв
I		  <i>Только XI в.</i>	 <i>A</i>
II			
III			
IV			 <i>A</i>
V			 <i>Только XIII в.</i> <i>A</i>
VI			
VII			
VIII			 <i>A</i>

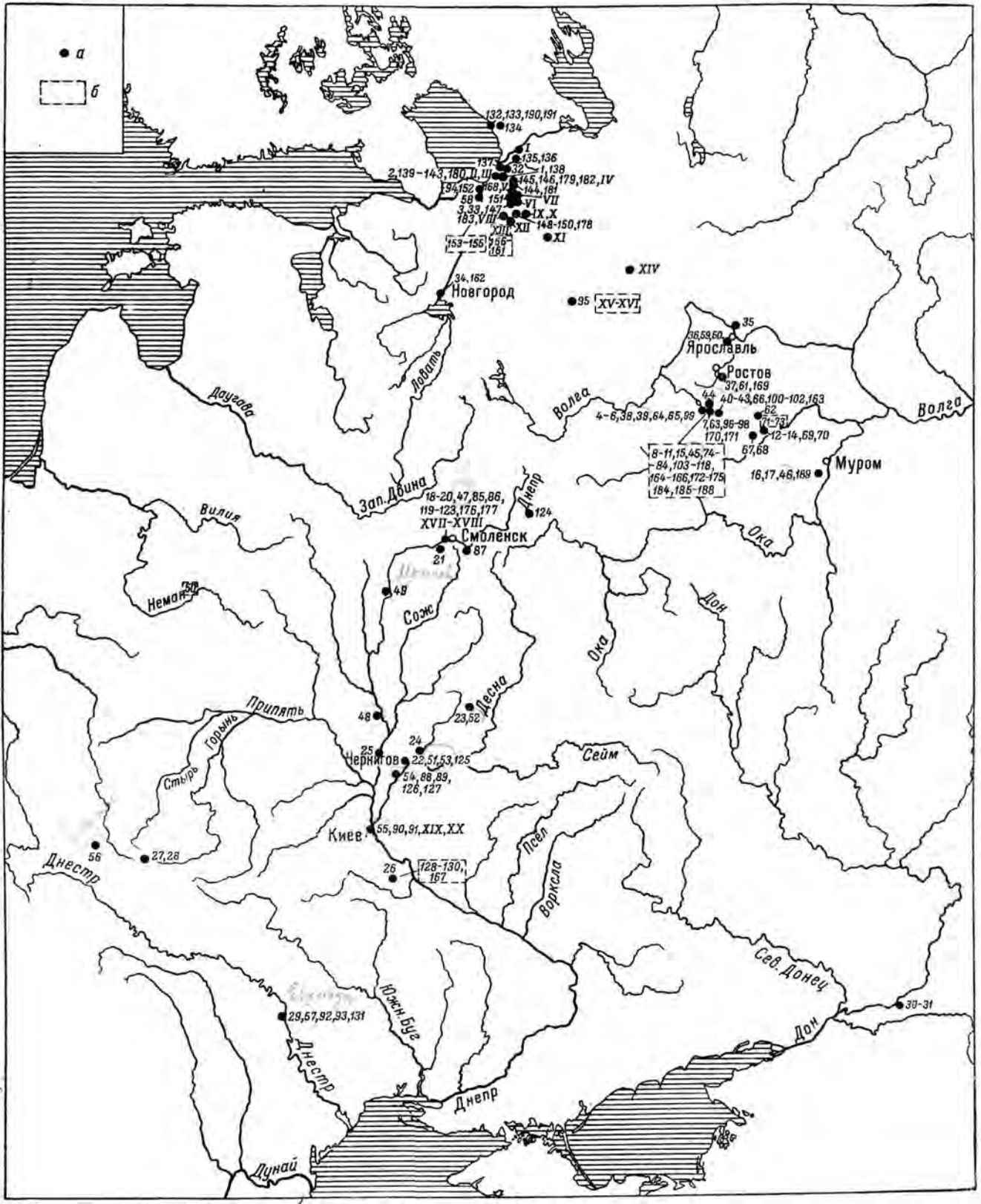

7.
1-191, I-XX —

X — XI

2.

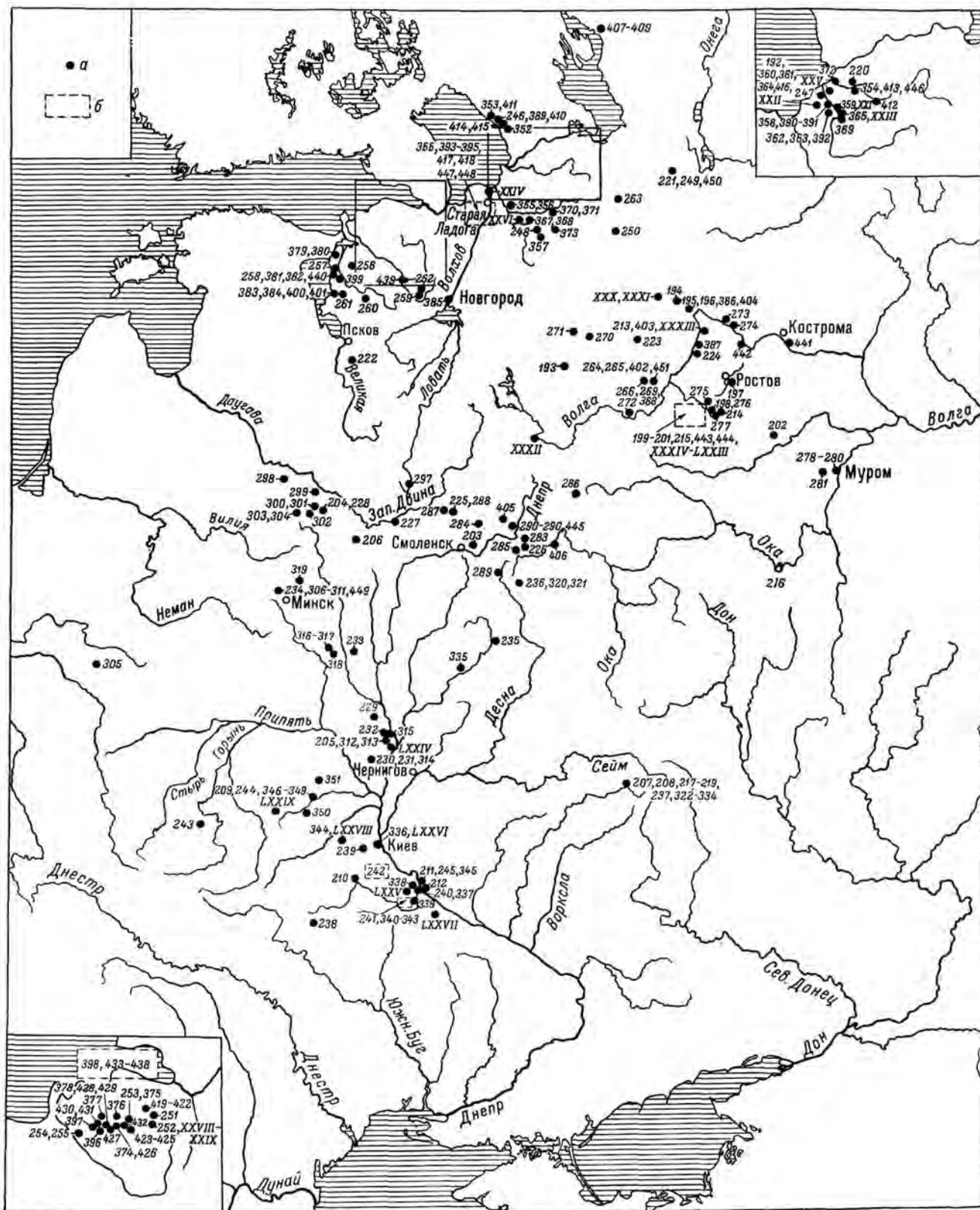

VI ³⁶

³⁷ VIII—IX

³⁴ 604. ³⁵ . . . 4, . . . 1935,

X . . . «

(. . . »

. . . 1926, . . . 65). X . . . 24,

³⁶ . . . 1901 . . . 111,

. . . 63; . . . I . . . i . . . i . . . i . . . i . . . i

³⁷ . . . XII, . . . i, 1961, . . . 36

. . . II, . . . 1889, . . . 126—127, . . . 43; 44;

. . . VIII, . . . 1900, . . . XI; XII, 7, 8 . . .

. . . XII . . . I, M., 1901, . . . XX,

3 5; . . . XLI,

. . . 99 . . . 30, 2; . . . MAP, 10, . . .

1893, . . . X, 7, 14, 16; . . . MAP, 26,

. . . 1902, . . . XXVII, 1 2; VIII—XI

. . . 1952, . . . XXXVI, 7 . . . XXII,

1955, . . . 169 . . . VI, 1, 3; . . .

. . . 1959, . . . 24, . . . 4, 6; 7; 8.

³⁸

X—XI

³⁹ X—XIII

95

2

(

XVII

XIII—XIV

3

I (. . . 25, 1—10;

31, 1, 3, 4; 32, 3 5)

X—XIII

XII—

XIII

(X—XI . . .),

(X . . .),

X—XI . . .),

³⁸

1956, . . . 375; J. Ham l. Alterthümer des frühen
Mittelalters in Ungarn, t. 1, Braunschweig 1905, . . . 97
; J. Schranil. Die Vorgeschichte Böhmens
und Mährens. Berlin, 1928, . . . 310, . . . LXX, 10;
J. Eisner. Devínska Nová Ves. Bratislava, 1952,
. . . 296—297, . . . 11, 5; . . . r dt. Contributii
la istoria transilvaniei. Bucuresti, 1958, . . . 9, c .
³⁹P. Paulsen. Axt und Kreuz..., . . . 38—49.
⁴⁰ . . . 38—45; . . . N d lski. Studia
nad uzbrojeniem polskim w X, XI, XII w i e k u . . . Łód ,
1954, . . . 40 c . ; . . . IX, 1.
. . . I, ⁴¹ . . . 1957,

(J. Kostrzewski. Kultura prapolska,
Pozna ⁴², 1947, . . . 337).

. . . I, . . . 1908, . . . 49; H. Miller.
Historische Waffen. Berlin, 1957, . . . 57.
⁴³ . . . 1—31, 192—212, 452—461 —
62 . . . 12. 5—19 (. . .)
8—15), . . . 3—6 ,
⁴⁴ 1. 8—2. 7 , . . . 200—340 . . .
(81)

IX—X

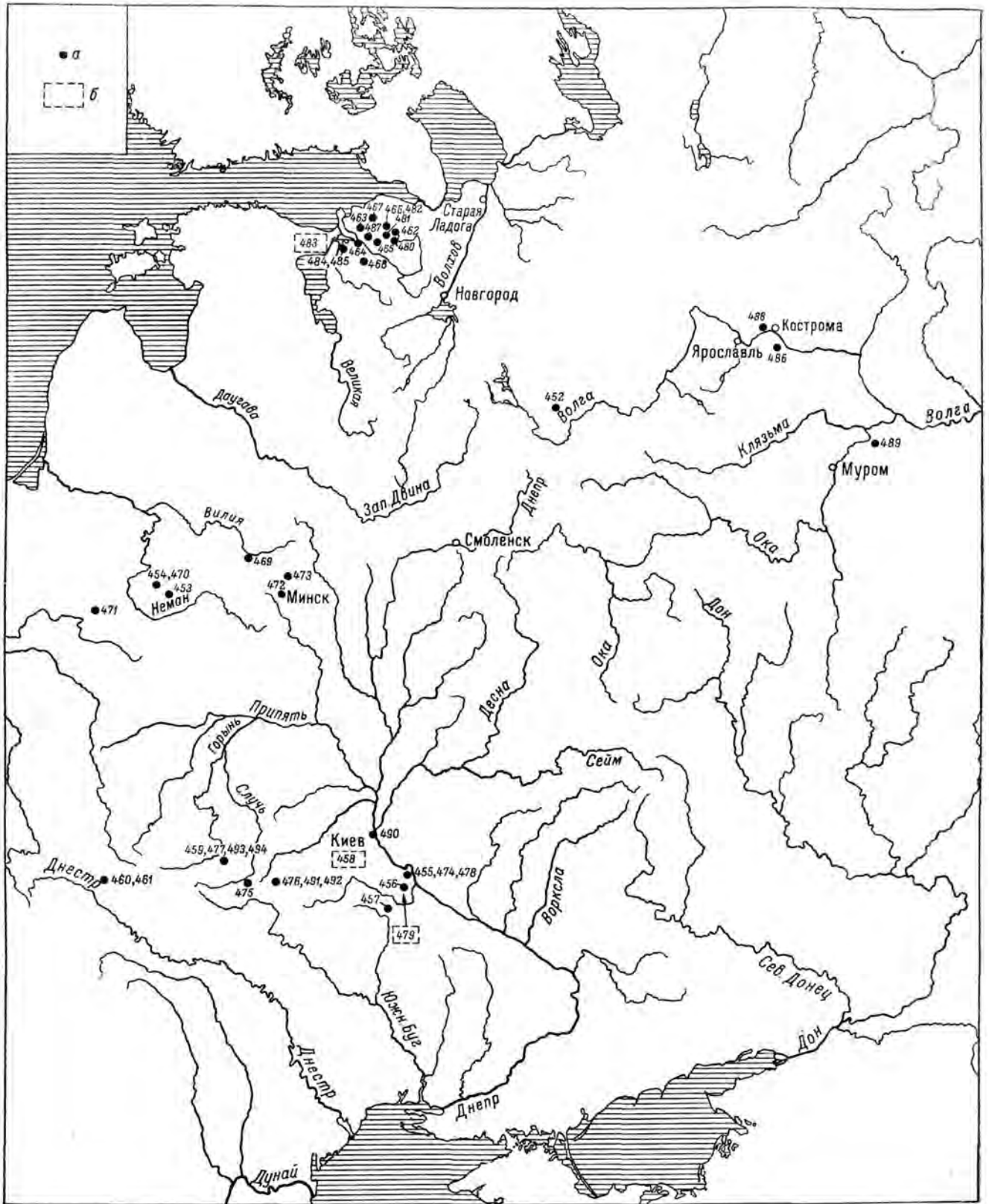

XI . . . (X—
 « (. 33, 1).
 XI . 46
 « »
 « »
 « ».
 2 «
 45 . . .
 46 (P. Paulsen. Axt und Kreuz...,
 . 124—130).
 47 . . . 129.
 48 . . . 1938, . 297.
 II, 49 . — . 78.

IA
 XI . . . (. 26, 7—9)
 3
 II
 XVII, 2; XVIII, 1 4).
 53
 X — XI .
 54'
 IA II XII—
 XIII . . . (I).
 « »
 (III)
 31, 7).⁵⁵ X—XI . (. 32, 1, 2
 III
 IX—X
 (. 34, 1).
 50 . . . 213—219 — 7 .
 I,
 9—10 .
 51 P. Paulsen. Axt und Kreuz..., . 44,
 12,
 52 . . . 32—57 — 26 — 8—11),
 6—12 , 2.5—
 3 1.5—2 .
 53 . . . 169, . VI, 2.
 54 P. Paulsen. Axt und Kreuz..., . 36—
 37, . 12, (11).
 II
 X . . . (,
 V-8943: 4).
 55 . . . 58—93, 220—245 — 62 .
 9—14 ,
 3. 6—5 , 1.5—2.7 , 200 .
 56 W. J. Raudonikas. Die Normannen der
 Wikingerzeit und das Ladogagebiet. Stockholm, 1930,
 puc. 5, a.

57 « »

()

« ».

« ».

».⁵⁹

« » « »

60

XII ..

2).

(. 33,

«

».⁶¹

III

XII .

III

: 1 —

, 1 — , 1 — , 1 — , 3 —

»

3

8

57 ivik ski. Die Eisenzeit Finnlands,
 t. II, Helsinki, . 36, . 1058; 1062 1064.
 58 , 1940, . 338.

59 . 34. —

(: . . , 1964, 3,

. 122 ., . 3).

60

(. . , . III, ., 1912,

. 892 980—981).

61 . 1, ., 1926, . 140 148; . .

. V, 1930,

. 116—120.

62 . 27/21 ; . . 1; P. Paulsen. Axt und
 Kreuz..., . 29—30, . 10, ; . Nad lski.
 Studia..., . 44, . XVI, I; .

63 P. Paulsen. Axt und Kreuz..., . 30.

X .

III,⁶⁴

IV,

(IV).⁶⁵ (

(144 .; 27, 3—8;
 31, 8; 32, 2; 35, 1, 2 8-12; 36,
 6; 38, 1) (112 .; . 30,
 2 37, 2 7), 14

66 XII . X .. XI—

XI .

()

()

(III). « ,

».⁶⁷

64 8 III
 (. XVI, I). XI—

XII . (: IV—V, , 1915,
 . IX, 2). III
 (., 19/11).
 65 , 94—131 246—351 — 144 .
 : 9—15 (13—
 15), 5—12 (7—9. 5),
 66 .: 1. 8—3 (2—3), 100—430 .

67 ., . 443, 444.

. 47.

) (: 1 —
 12 — , 4 — ,
 86 — , 16 — , 8 — , 1 — ,
 68 .
 25 . 69
 X IV.
 XI .
 70
 71
 1000 .
 X—XI .
 (,) .
 X—XI .
 (,) .
 68 . MAP, 10,
 1893, X, 4; Ilgren. Collection
 Zaoussailov, II. Helsingfors, 1918, III, 8—9;
 119/52; Paulsen. Axt und Kreuz...,
 27—33; A. Nadolski. Studia..., 46,
 XVI, 1; J. Filip. Pravekó Ceskoslovensko.
 Praha, 1948, 28—29;
 MAP, 14, 1893,
 S natn un Maksla, II, Riga, 76, 5, I. —
 IV
 69 P. Paulsen. Axt und Kreuz..., 29.
 70 IV,
 IX . (. . 74,
 1958, 71 . XXXIX).
 (P. Paulsen. Axt und Kreuz...,
 141).
 72 . . 140.
 . . 1948, . 140.

XI . 10
 . 9 . 10
 73
 XII—XIII .
 : ,
 (IVA).⁷⁴
 9, 10; 38, 2 102 — . 19, II; 27,
 30, 4)
 X—XI . , , , 75
 76
 IVA :
 (,) ,
 77 XII—XIII . ,
 » (V) «
 78 V X —
 XII . (. 19, 3;
 28, 1—4; 31, 5; 37, 5)
 (. 30, 3, 6; 31, 9). 170
 19
 79 X .
⁷³A. Nadolski, A. Abramowicz,
 Poklewski. Cmentarzysko z XI wieku w Lu-
 tomiersku pod Łodzi. Łódź, 1959, 52 .
 XXXV; XXXVI.
⁷⁴ . 462—477 — 16 . 8—12 :
 12—13.5 , 300—370 .
⁷⁵ . (,
 15/32).
⁷⁶ .
 48.
⁷⁷ . Paulsen. Axt und Kreuz..., 34—
 35, 11a; A. Nadolski. Studia..., 45—
 46, XVI, 6; Latviešu kult ra senatn . Riga, 1937,
 LV, 3. —
 ; 1911—1912 . . 56,
 ., 1914, IVA 196, . 50, 2. —
 X .
 XI—XII .
⁷⁸ . 132—167 352—388 — 73 .
 : 8—15 (10. 5—14. 5),
 6—10 500 . 2—
 3. 2 1. 5—3 ,
⁷⁹ 444, 445.

XI — XII .
 .
 .
 .
 V
 X
 XI .
 .
 .
 VII—VIII .⁸⁰
 () .⁸¹ X — XII .
 V, ⁸² ,
 .⁸³
 , X—XII .
 ,
 XIII .
 « »
 ,
 (VA).⁸⁴
 (2 30, 9)⁸⁵ . 28, 6 8
 ,
 XIII—XIV .
 .⁸⁶

⁸⁰J. Petersen. De norske vikingsverd. Kria, 1919, . 39, . 32; H. Salmo. Die Waffen der Merowingerzeit in Finnland. SMYA, XLII, Helsinki, 1938, . 263—266, . XXXVII, 5; P. Paulsen. Axt und Kreuz..., . 24—25.
⁸¹ . 1360.
⁸² Kivikoski. Die Eisenzeit Finnlands, . 825 . 19—20.
⁸³Latviesu kult ra senatn . Riga, 1937, . XLIV, 14; . . . XXX, 2.
⁸⁴ . 478—479. : 10—12. 5 , 4. 6—8. 3 , 2—2. 7
⁸⁵ . 41, 1954, . 164, . 84, I.
⁸⁶ . . . X, . . 1948, . 309; 1897, . 464, . 116; S natn un Maksla, II, 1936, . 76, . 5, 5; J. Durdik. Sztuka wojenna hutyów. Warszawa, 1955, . 104.

(VI; . 28, 7—10; 31, 6; 35, 13; 36, 7; 37, 9).⁸⁸
 (155 ., 14
 . 30, 7, 8).⁸⁹
 1000 ., XII—XIII .⁹⁰
 .⁹¹
 X
 XI ., ,
 ,
 IV
 XI . VI
 VI
 IX .⁹² XI—XII . (VIII—
)⁹³
 ()
 ()
⁹⁴ XI XII .
 .⁸⁷ .
 . 56, 1954, . 55, . 24.
⁸⁸ . 168—177 389—406 — 28 .
 : 11—15. 5 ,
 6—12 . 2. 3—3 1. 8—2. 6 ,
⁸⁹ 300—400 .
 : . . . 445, 446.
⁹⁰ . . .
 ., 1954, . 12, . 1, ; . . X, 1931, . V,
 7 8;
⁹¹ 65, 1959, . 27,
 . 10, 2.
⁹² 22
 . 8 ; J. ulik. Staroslovanska Moravva. Praha, 1948,⁹³ . 183, . LXXVII, 9.
 : . . . Kivikoski. Die Eisenzeit Finnlands, . 822. — (. 15/41 15/32).
⁹⁴ XXX, I.

95 , 1096 . VII

96 , 103

IV, V VI IVA VA 104

(VII; . 29, 1-5 36, 1). 97

4: 5

1: 1. 98

X XI . (

VII. XII—XIII 4

99

(. 30, 10). 100

1000 101

(1066—1082 .). 102

XI

95 I 58, 1957, . 213, . XXXIV, 3.

96 , 178—179 407—445, 480—486 —

97 : 13—20 (17—22 (

48 17—18), 3. 5 2—2. 5 , 200—450 .

98 . 41.

99 VII (48, 49)

100 446).

... , 27, . 10, 4;

V, 6.

101 J. at r sen. De norske vikingesverd, . 46—47, . 44; 45; . i vikoski. Die Ei-
senzeit Filmlands, . 19 . 821; P. Paulsen. Axt und Kreuz..., . 19—21. —

102 The Bayeux tapestry. New York, 1957, . 66, . 12

XII—XIV 105

(VIII; . 29, 7 III, 30, 11). 106

(23'). 107

X—XI

V—IX

(I), 108

X—XI

109

(-

103 Nad lski. Studia..., . 43

104 XIV, I.

VII

(. . I—IV, ., 1871—1887, . 55, 2; . : . 3)

105 Latviesu kult ra senatn . Riga, 1937, . XV, I3. — XIII—XIV

« »

S natn un M ksla, II, 1936, . 76

14 5—6 , 180—189 446—449 —

107 : 9—16 2—4 1. 5—2 .

108 446, 447.

40, 109

I

V.

,¹¹⁰ 1000 .
XI ().
XII—XIII .
(VIII A).¹¹¹
(2: 1 1. 5: 1)

(. 29, 8, 9 30, 12).
IVA).
XIV—XV .¹¹²
(. 34, 3).
,¹¹³
(. 34, 3).
,¹¹⁴
(. 34, 3).
,¹¹⁵
XII—XIII .¹¹⁶

5) 4
X (. 30, 5)¹¹⁷ — 28,

¹¹⁰ . 41;
5—11¹¹¹ 13. . 27, . IX,
¹¹² , 487—494 — 8
¹¹³ . 26.
¹¹⁴ , 1950, . XII, 11.
XII, 9. —
¹¹⁵ . V, . — ., 1940, . 304—305,
¹¹⁶ . 1. i v i k s k i . Die Eisenzeit Finnlands,
¹¹⁰⁹ ; 1110.
¹¹⁷ , 190—191.

(-)
80
XI .
IV)²
II).
29, 6)¹¹⁹ (;

, X — XI . (. 7)
X —
I II)
V VII),
III IV).

III IV). (I, II,

(V, VII, VIII),
1000 . (, IV)
XI .¹²⁰ X —

¹¹⁸ i v i k s k i . Die Eisenzeit Finnlands,
823. —
¹¹⁹ . 27, . 10, 1).
¹²⁰ , 450—451.
MAP, 25, ., 1901, . 51 107.

Район или место находки	Типы										Всего
	I	II	III	IV	V	VI	VII	VIII	A	неизвестен	
Юго-Восточное Приладожье	3	2	1	1	30	1	2	4	2	13	59
Новгород	—	1	—	—	1	—	—	—	—	—	2
Ярославская обл. (Михайловское и Большое Тимерево)	—	2	2	—	—	—	—	—	—	—	4
Калининская обл.	—	—	—	1	—	—	—	—	—	3	4
Ярославская обл. (Сарское)	—	1	1	—	—	1	—	—	—	—	3
Суздальское Ополье	12	8	23	23	4	6	—	5	—	—	81
Подболотье, ок. Мурома	2	1	—	—	—	—	—	1	—	—	4
Смоленская обл. (Гнездово)	3	1	2	5	—	2	—	—	—	2	15
Смоленская обл.	1	—	1	1	—	—	—	—	—	—	3
Минская обл. (Козлово)	—	1	—	—	—	—	—	—	—	—	1
Западная часть Белоруссии (бывш. Лидский у.)	—	1	—	—	—	—	—	—	—	—	1
Могилев	—	1	—	—	—	—	—	—	—	—	1
Чернигов и окрестности	3	3	—	1	—	—	—	—	—	—	7
Черниговская обл. (Шестовицы)	—	1	2	2	—	—	—	—	—	—	5
Черниговская обл. (Любеч)	1	—	—	—	—	—	—	—	—	—	1
Киев	—	1	2	—	—	—	—	—	—	2	5
Киевская обл.	1	—	—	3	1	—	—	—	—	—	5
Львовская обл. (Подгорцы, Глинское)	2	1	—	—	—	—	—	—	—	—	3
Молдавия (Екимауцы)	1	1	2	1	—	—	—	—	—	—	5
Ростовская обл. (Цимлянская)	2	—	—	—	—	—	—	—	—	—	2
Итого	31	26	36	38	36	10	2	10	2	20	211

(I—III)

XI—XII

(319 366 ; . 8).

VA, VIIIA).

(IVA,

(VIIIA).

IV.

« »

XII—XIII

(I)

VII

XI (IA).

(IVA, VA, VIIIA)

XIII—XV

XII—

(VA).

XIII

VII,

XII—XIII

XII—XIII

XI—XII . (. 9),

XI—XII . ()

Район или место находки	Типы										Всего
	I	IA	III	IV	V	VI	VII	VIII	Б	неизвестен	
Заонежье (Челмужи)	—	—	—	—	—	—	3	—	—	—	3
Юго-Восточное Приладожье	1	—	1	3	22	7	9	1	—	6	50
Вологодская обл.	—	—	1	2	—	—	—	—	1	—	4
Западная часть Ленинградской обл. и Гдовщина	—	—	1	11	11	6	22	2	—	3	56
Новгород	—	—	—	2	1	—	—	—	—	—	3
Костромская обл.	—	—	—	—	—	—	1	—	—	—	1
Калининская обл.	2	—	1	9	1	1	—	—	1	3	18
Ярославская обл.	3	1	1	2	2	2	1	—	—	1	13
Суздальское Ополье	5	2	—	3	—	—	2	—	—	40	52
Муром и округа	—	—	—	4	—	—	—	—	—	—	4
Старая Рязань	—	1	—	1	—	—	—	—	—	—	2
Смоленская обл.	1	—	2	14	—	2	1	—	—	—	20
Витебская обл.	—	—	1	2	—	—	—	—	—	—	3
Западная часть Белоруссии (бывш. Виленская губ.)	1	—	1	6	—	—	—	—	—	—	8
Минская обл.	1	—	6	14	—	—	—	1	—	1	23
Гродненская обл.	—	—	—	1	—	—	—	—	—	—	1
Могилевская обл.	1	—	1	—	—	—	—	—	—	—	2
Калужская обл. (Трапковичи)	—	—	1	2	—	—	—	—	—	—	3
Курская обл. (Гочево)	2	3	1	13	—	—	—	—	—	—	19
Черниговская обл.	—	—	—	1	—	—	—	—	—	—	1
Киев и область	1	—	5	9	—	—	—	—	—	5	20
Вольнь	1	—	2	6	—	—	—	—	—	—	9
Полтавская обл.	2	—	1	1	—	—	—	—	—	—	4
Итого	21	7	26	106	37	18	39	4	2	59	319

XII—XIII . ()

Район или место находки	Типы					Всего
	I	IVA	VA	VII	VIIIA	
Западная часть Ленинградской обл. и Гдовщина	—	7	—	6	1	14
Костромская обл.	—	—	—	1	1	2
Калининская обл. (Васильевское)	1	—	—	—	—	1
Горьковская обл. (Малое Терюшево)	—	—	—	—	1	1
Западная часть Белоруссии (бывш. Виленская губ.)	2	2	—	—	—	4
Минская обл.	—	2	—	—	—	2
Гродненская обл.	—	1	—	—	—	1
Киев	—	—	—	—	1	1
Киевская обл.	4	1	2	—	—	7
Житомирская обл. (Колодежное, Райки)	—	2	—	—	2	4
Хмельницкая обл. (Городище)	1	1	—	—	2	4
Дрогобычская обл. (Ступница)	2	—	—	—	—	2
Итого	10	16	2	7	8	43

XIII . (. 10; 11),

Назначение	Форма лезвия	Типы	Количество
Специально боевые.	Узколезвийная, треугольная. Трапецевидная. Оттянутое книзу.	I, III	124
		II	26
		IA	7
Универсальные.	«С выемкой и опущенным лезвием» (бородовидная). Широколезвийная, треугольная. Узколезвийная, клиновидная.	IV, IVA, V, VA, VI, A	265
		VII, B	50
		VIII, VIIIA	22

IV—VIII).

124

(. 12)

121

122

X—XIII

11

Дата	Типы и назначение														Всего	
	Специально боевые				универсальные								редкие			неизвестен
	I	IA	II	III	IV	IVA	V	VA	VI	VII	VIII	VIIIA	A	B		
X—начало XI в.	31	—	26	36	38	—	36	—	10	2	10	—	2	—	20	211
XI—XII вв.	21	7*	—	26	106	—	37	—	18*	39	4*	—	—	2*	59	319
XII—XIII вв.	10	—	—	—	—	16	—	2**	—	7	—	8	—	—	—	43
Итого	62	7	26	62	144	16	73	2	28	48	14	8	2	2	79	573

* XI
** III

(IV).

123

(« ») (?), (VII).

124

X—XIII , . 4, 1946,
14.
122 , 58, 94, 201, 274, 289, 488, 491, XI,
XXXII, LXXVI—LXXVII. —

XII

123

, 1898, . 4, . 25—26.

XIII . XII—
 X .),
 X—XI
 «
 »
 (I—III),

12

X—XIII

Типы	X—начало XI в.			XI—XII вв.			XII—XIII вв.		
	боевые	рабочие	рабочие в комплексах с оружием	боевые	рабочие	рабочие в комплексах с оружием	боевые	рабочие	рабочие в комплексах с оружием
I	31	—	—	21	—	—	10	—	—
IA	—	—	—	7	—	—	—	—	—
II	26	—	—	—	—	—	—	—	—
III	36	—	—	26	8	—	—	—	—
IV	38	11	2	106	101	12	—	—	—
IVA	—	—	—	—	—	—	16	102	—
V	36	24	12	37	146	7	—	—	—
VA	—	—	—	—	—	—	2	8	—
VI	10	1	—	18	97	8	—	57	6
VII	2	—	—	39	—	—	7	29	2
VIII	10	65	21	4	14	1	—	—	1
VIIIA	—	—	—	—	—	—	8	93	—
A	2	4	—	—	—	—	—	—	—
B	—	—	—	2	—	—	—	—	—
Всего	191	105	35	260	366	28	43	289	9

« »?

X — XI .

X .

970—971

125

II 1008 .

126

XI—XII

XII

XI—

(,

XI—XII

XI—XII

XII—XIII

1216 ¹²⁷

1219 .

125

1820, 92.
¹²⁶N. Niedrl . Slovanské starožitnosti, díl III, sv. 2. Praha, 1925, . 522 527.

1216 .

: «
 ,
 ,
 ».¹²⁸
 (. 128 .),
 1093 . ,
 — VII), (,
 1240 . «
 ».¹²⁹
 1071 .
 : «¹³⁰
 ».
 131 XI . 141
 «
 132) (. 41,
 ».¹³³
 134
 135
 136
 128 1219 . 1240 .
 129 . 1071 . » (. . 6,
 130 . 1899 . 88).
 131 1071 . «¹³⁷W. Boehm. Waffenkunde. Leipzig, 1890,
 . 367—368.
 132»
 «¹³⁸The Bayeux tapestry, . 64.
 »
 » , 1861, 1, . 1—3. 1216 .
 133 . 1944,
 134 .
 . 22 . 19;
 135 . 1960, 4, . 39. — 142 ., 1948, . 404).
 136 . , 1944,
 . I.
 «
 (.

XII—XIII .

, ,
 ,
 ,
 ,
 ,
 1620 . , . II. ., 1867, . 378).

.
 ▭ ,
 ,
 ▭ « . X .
 ». XI—XIII .
 ,
 ▭
 ▭



3

()

□
□

a. ³

□
□

XII—

XIII

102
XI—XIII .⁵

6

(. 10; 11).

³H. Schumann. Bronzekeule (Morgenstern) von Butzke (Pommern). Verhandlungen der Berliner Gesellschaft für Anthropologie, Ethnologie und Urgeschichte. Berlin, 1897, . 241—246; XI AC . 1899, . 49, 26.
⁴ . I. M. — . 1948, . 432—433; . 1951, . 33;
⁵ 65, 1959, . 132—137. I—VIII.

¹ 40 □
(. 1904, . 35—36).
² II, . . 1910, . 84—88; VIII, . 1900, . 32 LIV, 3
 II, . . 2. 1897, . XIII, . 5 . 6; VII, . 2, 1907, . 248, . 31; . F. A. Schaeffer. Stratigraphie comparée et chronologie de l'Asie Occidentale. London, 1948, . 239, 21



(II).¹⁵

XIII (. 39, 3) XII—

II

(, —)⁷

(,)

. 39, 1, 2; 42, 1).⁹

(I;

XI

(. 40, 5)

IX—XI

II

(,),¹³ 16

,¹²

,¹⁴

I

⁶ . . . 1) . . . 35; 2)

1902, . 59.

⁷A. Stein. 1) Serindia, v. IV, Oxford, 1921, VII, -0081; 2) Innermost Asia, v. VII, Oxford, 1928, LXXI, Kao-028. — X

⁸ . . . ³.
⁹ . . . 1—3.

1906 . . . 1, 1906, 30, . 48. — ¹⁰ X—XI

¹¹ . . .
¹² 1893, . 125, 36; . . . 400 (6234).

¹³(. . . . 43/2).

. . . X, . . . 1905, . 320—321; . . . 1905, . LXIII, 15.

¹⁴ . . . r a u n s r g r . Nesto starom hrvatskom oruzju. Narodna starina, t. XI, Zagreb, 1932, . 130, . I, 1.

,¹⁶ ¹⁷ ,¹⁸ ,

XVII .

. 39, 4). (II ; 49—50, — « » —

(²⁰)

« XV .

²¹

XII—XIII .,

(I).

¹⁵ . . . 4—48 — 45 .,

¹⁶ 100—350 . . . 30/71 30/72;

(. . .).

¹⁷ . . . , 1962, . X, 22.

¹⁸W. Gaerte. Urgeschichte Ostpreußens. Königsberg, 1929, . 340, . XV, d.

¹⁹ . . . 3, ., 1885, . 5, 5182. — . . . 4,

²⁰ . . . II , . I, ., 1876, . II, 7 9;

²¹ . . . , 1894, . 135—136, . 215; . . . XV .

. . . 132, . 5, 5 6 . 133.

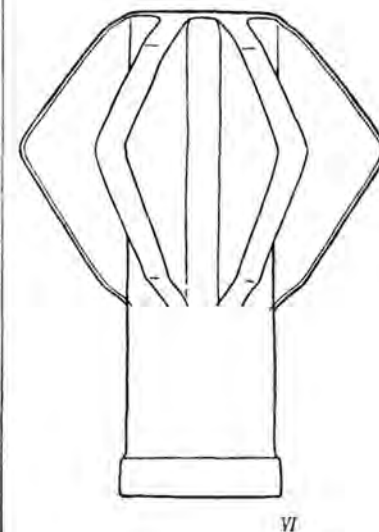
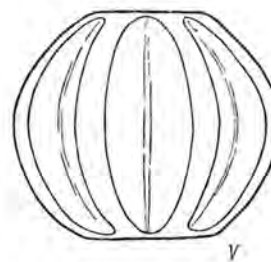
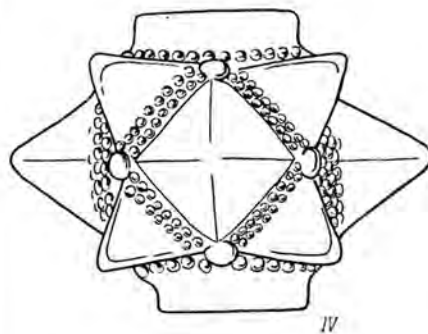
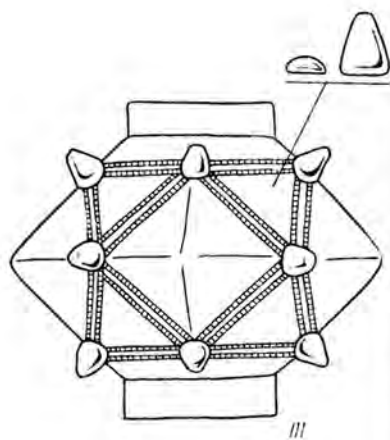
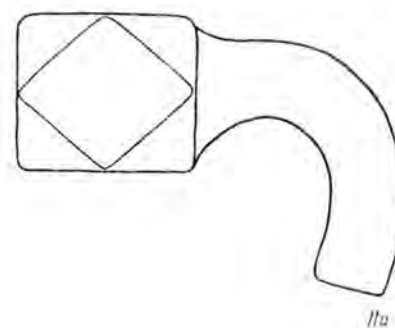
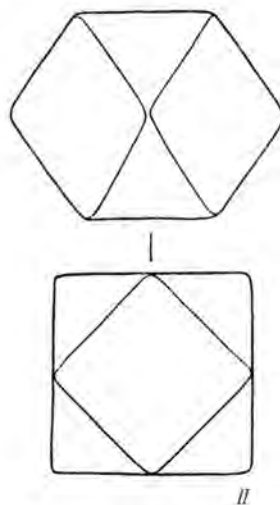
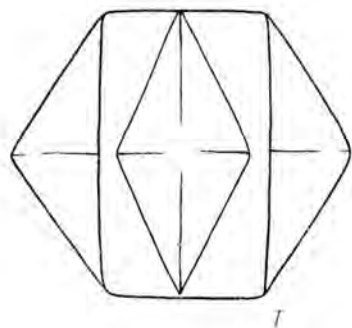

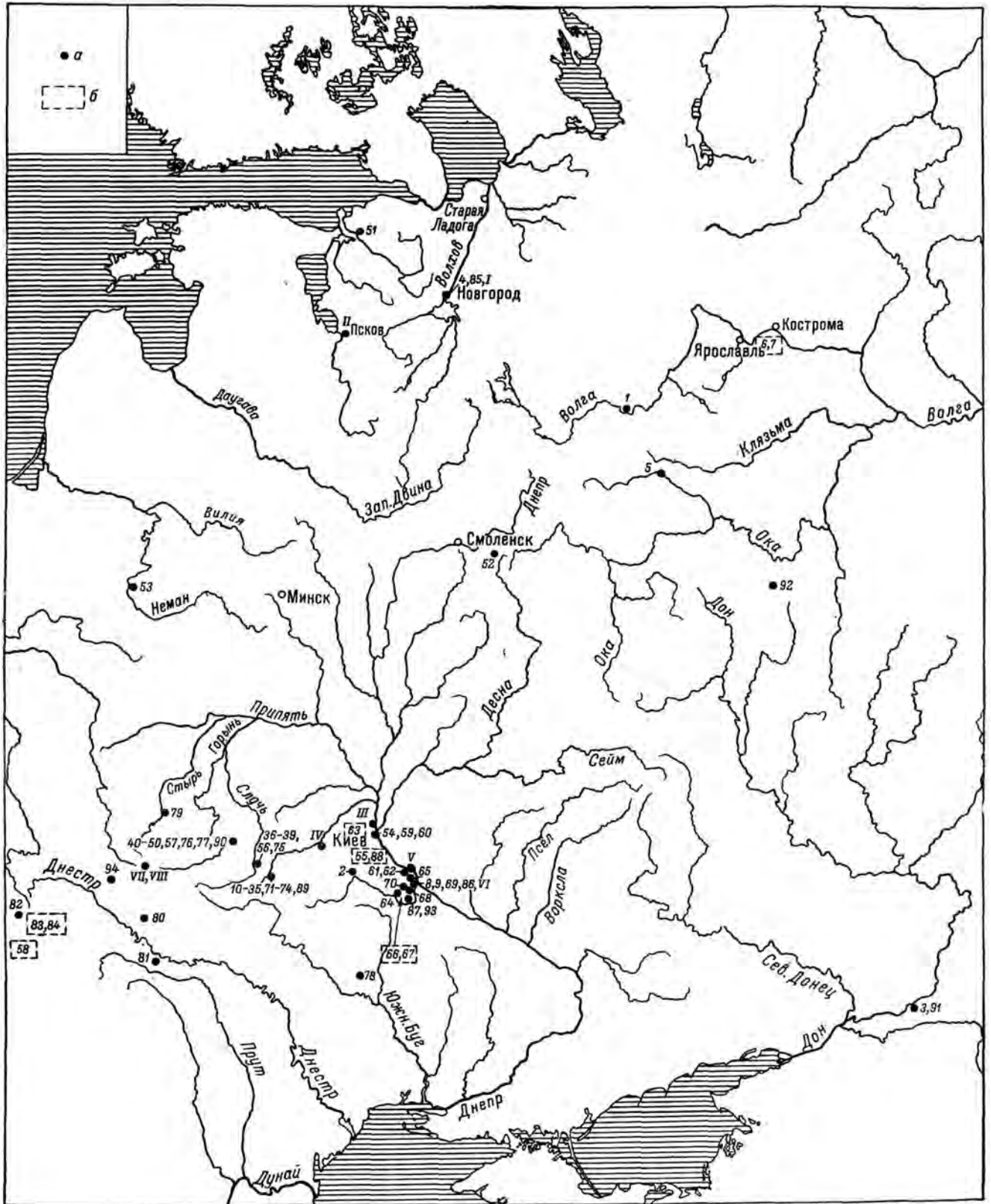

200—300²² ,
 (51;
 43, 5),²³ —
 (54; . XXXVI, I) — (, 52),²⁴
 (75) —²⁵
²⁶
 (III).²⁸
²² 1950, . 95.
²³ 1903
²⁴ . VII, . 1, ., 1905, . 140, . 84.
²⁵ . 111, . 56.
 1958,²⁶ P. . 310—316.
 . XII,²⁷ i , 1961, . 97.
 (III IV)
²⁸ , 51—58 — 8 ., 250—300 .
 III (. 10): — (62);
 (51, 56); (53, 54, 57, 58).
 III,

40, I—3 . 43, I 3) (.
 ()
 (. 40, I)
 , «
 ».²⁹
 «
 ».³⁰
 ()
 31
 ?
 (?)
 1876³²
 XIII
 (.
 ,³³
²⁹ 1958,³⁰ . 316.
³¹ . 316.
 ,, 1948,³² . 150.
 114,³³ 921—930. XI , . 113—
 . 25.

(57).

IV

III) XII — IV (

XIII . 40

35 , 36

(52).

34

41

40, 3), 37 38

(

IV

42, (IV; 2-4; 43, 2). 40, 4; 41, 1-7; 39 12

2 1. (60) (66) —

2. (59), (68), (81), 42 —

III)

4 3. 43 — 2 (61)

(67—68, 79, 80, 83—84).

4. (62) 44 — 2

».⁴⁵

³⁴R. Hausmann. Katalog der Ausstellung zum X archeologischen Kongress in Riga 1896. Riga, 1896.³⁵ . 61 . 26, 18.

⁴⁰(OAK 1906, . 98—99, . 127; . 21/ 50)

1893 1894 . III, M., 1899, . 64, . 21.

XIII—XIV
⁴¹S. Nilsson. Die Ureinwohner des scandinavischen Nordens. Hamburg, 1866, . 3, 33; J. Rinne. Sotaniijista museomme kokoelmassa, . 56, . 11; H. Schumann, Bronzezeule..., . 242, . 1; L. Lindenschmit. Die Alterthümer unserer heidnischen Vorzeit, Bd. I, Heft VIII, Mainz, 1864, . II, 5 (

³⁶ . II , . II, 5.

³⁷ 5225.

³⁸

(J. Rinne. Sotaniijista museomme kokoelmassa. Suomen Museo, t. XVI, Helsinki, 1909, . 50—59, . 3 . 51; H. Lildebrand. Sveriges medeltid, t. II, Stockholm, 1884—1898, . 364, . 195).

. 66—67, . 25, I 2; D. D. Preradovi . Die im Museum altkroatischer Altertümer zu Knin (Dalmatien) befindlichen Waffen. ZWK, Bd. IV, Heft 4, 1906, . 101, . 8; A. M. Tallgr n. Kollektion Zaoussailov, t. II. Helsingfors, 1918, . IV, 37.

91). ³⁹ , 59—84 — 26 ; 200—300 , — 150—180 .

1957 .

IV XI—XIII . ()

⁴³W. Grtte. Urgeschichte Ostpreußens, . 340 . XV, .

(MW, t. V, Warszawa, 1960, . 254 . XXIII, 8).

⁴⁴R. usmann. Katalog der Ausstellung..., . 61, . 26, 17.

⁴⁵ . 458.

(75) — 3 (63), (71),

(41, 2).
« »

(41, 4),

46

(77) 49
(
41, 5) (76; 50

()

(83—84)⁵¹, (80)

47

« »

48

()

IV XIII XII—

17⁴⁹ 19.
⁵⁰ Hildebrand. Sveriges medeltid,
³⁶⁴ 197.
⁵¹ Nadolski. Studia nad uzbrojeniem polskim w X, XI i XII wieku. *Łódź*, 1954, XXXIII, 5.

249.

47

XV—XVII

48

(S. L. I d
and J. Sellart. Beycesultan excavations. Anatolian studies, v. VI, Ankara, 1956, 106. XII, a).

(94).
 V
 XIII .
 (. 13; 14).
 I.
 XIII V), XI . (I, XII—
 (V; . 39, 5) ⁵³
 XII—
 XIII ⁵⁵ .
 (. 87; . 89; . 90).
 (6 8).
 XIV—XVI ⁵⁶ .
 (VI)
 XII ⁵⁷ .
 (92), ⁵⁸ 6) XIII . ((93)
⁵³ 150—180 . 85—91 — 7 .
⁵⁴
⁵⁵ XII—XIII .
 (W. G r t e . Urgeschichte Ost-
 preußens, . 340, . XV, . ; . Hildebrand .
 Sveriges medeltid, . 364, . 194; 196; 198; 199).
⁵⁶ 1502 .
 (. III . j (1307 .)
 j . 48, 6; . : W. Rose. Die Bedeutung des goti-
 schen Streitkolbens als Waffe und als Würdezeichen.
 ZWK, t. II, Dresden, 1900—1902, . 359—366.
⁵⁷ A. . A p x . . 1944, . 9;
⁵⁸ . . 193 . (.).
 OAK 1898 . . 1901, . 77, . 132); (.
 (. 30/159), 4 . 450 .
 (. 1840 .

(94).
 V
 XIII .
 (. 13; 14).
 XI . (I, XII—
 XIII V), XI . (I, XII—
 II, IIA, III—VI). (.
 IV) (II , III
 90% (90 .)
 XIII—XIV .
 XIII .
 « XIII » ,
 200—300 . 50—
 60 ⁵⁹
 () —
 /238, /753, /755.
 . . 1950, . 21; .
 . . 1963, 4, . 239
 XIII—XIV ; XIII .
 (. : J. Szend-
 r j. Ungarische Kriegsgeschichtliche Denkmäler. Bu-
 dapest, 1896, . 97; R. E. akesh tt. The archa-
 eology of weapons. London, 1960, . 258, . 127).
 (61—62)
 2. 6 50 (. : . 132).

XI—XIII . ()

Район и место находки	Типы								Всего
	I	II	IIA	III	IV	V	VI	неизвестен	
Ленинградская обл. (Мануйлова)	—	—	—	1	—	—	—	—	1
Новгород	—	1	—	—	—	1	—	1	3
Псков	—	—	—	—	—	—	—	1	1
Москва	—	1	—	—	—	—	—	—	1
Калининская обл. (Загорье)	1	—	—	—	—	—	—	—	1
Костромская обл.	—	2	—	—	—	—	—	—	2
Смоленская обл. (Бородино)	—	—	—	1	—	—	—	—	1
Пронск	—	—	—	—	—	—	1	—	1
Гродно	—	—	—	1	—	—	—	—	1
Киев	—	—	—	1	2	—	—	—	3
Киевская обл. (Княжа гора, Сахновка и др.)	1	2	—	1	10	3	1	4	22
Житомирская обл. (Райки)	—	26	—	—	4	1	—	—	31
Житомирская обл. (Колодежное)	—	4	—	1	1	—	—	—	6
Хмельницкая обл. (Городище)	—	9	2	1	2	1	—	—	15
Хмельницкая обл. (Межерички)	—	—	—	—	1	—	—	—	1
Вольнская обл. (Гульнице)	—	—	—	—	1	—	—	—	1
Львовская обл. (Звенигород, Подгорцы)	—	—	—	—	—	—	1	2	3
Тернопольская обл. (Зеленча)	—	—	—	—	1	—	—	—	1
Черновицкая обл. (Василев)	—	—	—	—	1	—	—	—	1
Закарпатская обл.	—	—	—	1	3	—	—	—	4
Ростовская обл. (Цимлянская)	1	—	—	—	—	1	—	—	2
Итого	3	45	2	8	26	7	3	8	102

XI—XIII . ()

	Типы								Всего
	I	II	IIA	III	IV	V	VI	неизвестен	
Количество	3	45	2	8	26	7	3	8	102
Дата	IX (?)— XI вв.	XII— XIII вв.	1-я пол. XIII в.	XII—1-я пол. XIII в.	XII—1-я пол. XIII в.	XI—XIII вв.	XIII— XIV вв.	XI— XIII вв.	

X—XIII

60

61

XII,

XIII

62

XVI .

»

63

»⁶⁴

60

35.

XII « . (. ah en. Un traité d'Armurerie composé pour Saladin. Bulletin d'études orientales, t. XII, Beyrouth, 1948, . 139—140).

⁶¹Archaeologia, v. 79, London, 1929, . V, 3 (XIII .

64

⁶²The Bayeux tapestry. New York, 1957, . 62

⁷³₆₃ j 87.

., 1908, . 274; XVI

, 1913, . 3, . III, . 14.

XVI—XVII . 65

?

73

1216 .

74

« . 66 » . 67

XII .

69

(1073 .) .

— . 193 . , (

j, j, j —

(— . 193 . ,

70

— . 198). ,

III IV),

(II).

75

76

XI .

XII .

XV .

— « . 71 » .

72

77

65

(. . 1877, . 188 227), . bul-
I, Bulle .
(. 528).

1216.

66

67

. 4, ., 1946, . 4.

68 JI.

1956, 69 . 375.

70

. I. ., 1893, . 1416.

73

71

— ., 1914, . 342. . I, — ., 1912, . 281; . II,

74

. 174—175.

187). 72

., 1896, . 17—18. —
1576 .

(. . X

XII—XIII .

., 1896, .
118 76 . VII, 653).
Iföldi. Die Goldkanne von St. -Maurice
d'Agaune. Zeitschrift für schweizerische Archaeologie
und Kunstgeschichte, Bd. 10, Heft 1—2, Zürich, 1948,
22—26, . 6, 4 16—18.
77 H. Müller. Historische Waffen. Berlin,
1957, . 60.

., 1854, (. 21).

(., 1890, . 69—71).

() □
 , , □
 () □
 « » □
 , □
 , □
 78 XI—XIII 943 . □
 , □
 , 79 □
 () , □
 80 « » , « » , « » , () □
 81 □
 78 . □
 943/4 . □
 XXIV, ., 1926, . 65. □
 79 □
 , III, ., 1903, □
 80 131. — □
 1256 .; . □
 , □
 99, 7, ., . 135, 141 . 142. □
 81 . □
 , 1960, 4, . 38. □

1151 . □
 : □
 « ».⁸² , □
 « »⁸³ □
 « » , , □
 (« » ... »).⁸⁴ □
 « » □
 , « » □
 85 □
 , « » □
 IX—XIII . □
 , , □
 , □
 , □
 82 1151 . □
 83 . □
 ., 1958, . 244; .: . □
 , . I, □
 . 733—734. □
 84 □
 85 1159 . □
 1114 . — □
 « » □
 , 1836, . 75 80). □
 » (. , 1836, . 75 80). □

4

«...»,
 1.
 2.
 3.
 1. . . . IV, . . . X 1901, . . . 17; . . .
 . . . 1, . . ., 1957, . . . 244; . . .
 XXXI, 18.
 2.
 «...».
 118, 3 . . . XXXIV, . . . 3—4, . . . 1929, . . . 113—
 . . . XV, . . ., 1895, . . . 167.

4.
 5.
 «...».
 6.
 7.
 : «...»
 8.
 4.
 5. 1948, . . . 249—250.
 6. . . . 52, . . ., 1953, . . . 10—16.
 7. . . . 65, 1959, . . . 137—138.
 8. . . . 137.
 . . . 1. . . ., 1912, . . . 342.

()

9

127 ()

(. 12; 13).

IV—IX ¹⁰ 11

X

44, 1—9).¹² (I;

(

X (XIII).

13

9 (81/55),

¹⁰P. Rau. Die Hügelgräber römischer Zeit an unteren Wolga. Pokrowsk, 1927, . 23 . 22, E; 1926, . XXVII, 4; . XII . I, . 1901, . XX, 7. — IX—X (. 48, 1956, . LIV, 6). 14 III 1960 . 1946 . (. 14).

11 kisczen, kes-

ten (. . V, . 1912, . 310).

¹² . 1—35, 100—250 .

¹³ . 75, 1959, . 72 . 21 . 71.

;

4

5

().¹⁴

;

XI . ¹⁵ (9)

¹⁶

(¹⁷)

I—4)¹⁸ (II; . 45, 1—4; 46, 4; 45, 5-10; 46, (II ; 6-12).¹⁹ . 43,

X . (

¹⁴ . 62, 1958, . 76 . 55 (

¹⁵ . X—XII .

VI, 1940, . 253—254.

¹⁶Fontes archaeologici posnanienses, v. XII, Poznań, 1961, . I, 12. —

XII — XIII .

i . z r i s k i. Ciekawy staroruski zabytek z Czerwienia. Z otchłani wieków XXXI. Warszawa, 1965, 3, . 238—241, . 2; 3).

¹⁷

(44, 46 47).

¹⁸ . 36—59 — 24 ., 63—

268 ¹⁹ . 60—81 — 22 ., 120—

235 .

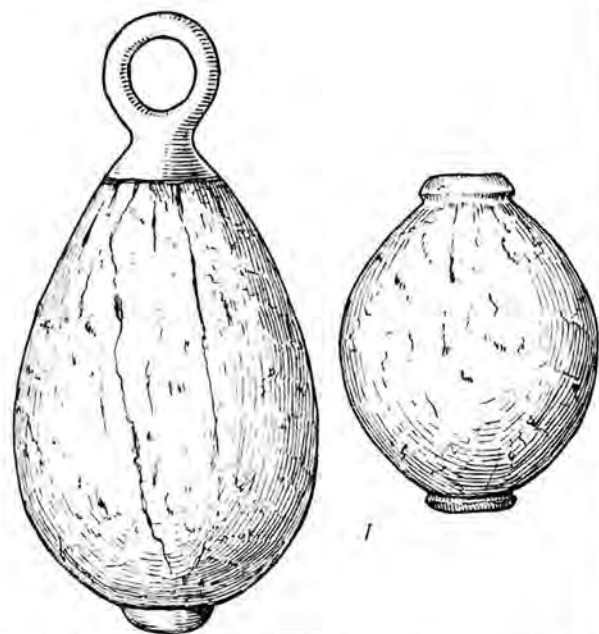

I

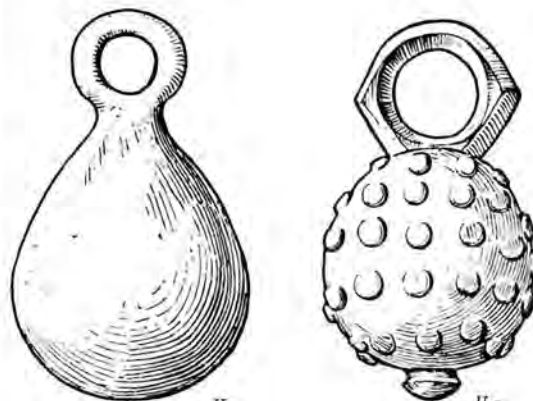

II

IIa

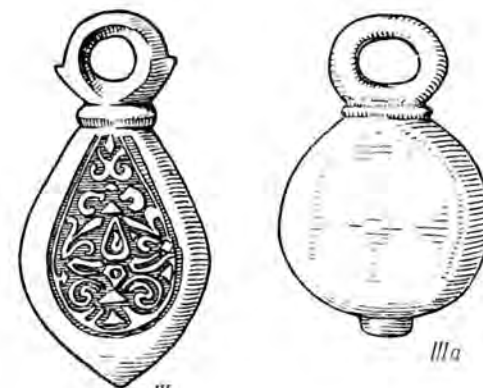

III

IIIa



IV

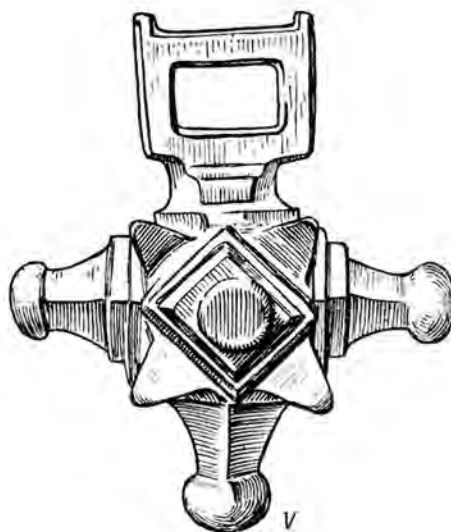

V



VI

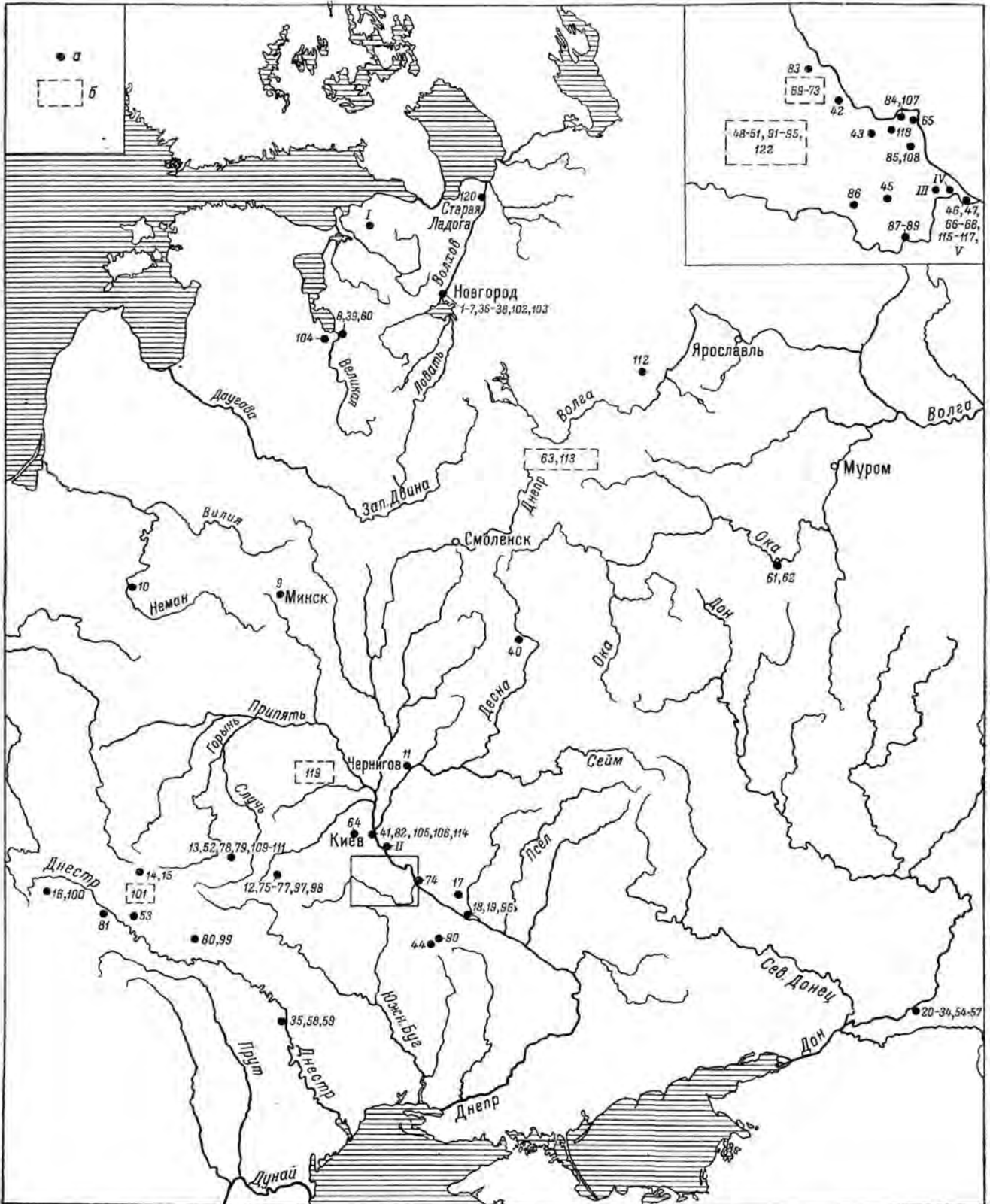

1—122, I—V —

13. X—XIII

2.

)
XII—XIII

(101).

X—XIII
(50 53)

« » (

XII : (

XII

XII — XIII

II

(1868).²⁴

(68, 74, 77)

8),²⁵

XII—XIII

XII (47;
26

(, , ,)²¹

47, I)

III

(86;

»

(65, 66 80).

XIII .²⁷

XII—

II ;²²

5; 47, I—5; XXXIV, 1-10).²³

43,

« » 75% (14 20)

98),

(97

.²⁸

20

. 52/3, 4).

(,

(85 101).

(?) — ., 1958, . 1, (. 83).

XIII ., . — ., 1954, . XXIX; XXXI; XLVII, 7;

22

« », 82—101 — I, 3 II; , . 19/41 .

.²⁵ ., 1936, . XXVI, I. 908/2.

300 (86, 88 89).

III,

.²⁶ ., -66163, -25/2582.
27 ., 1887, . LIV, I; LVIII, 14; LX, 39;

(. XXXIV, 8—10).

LXI.²⁸ 2. : 84, ; 87, ; 90, ; 91—94, ; 99, .

(XII—XIII .).
 , 1240 . —
 (XII—XIII .)
 XIII .
 « »
 (IIIA; . 46,
 5 47, 6).²⁹
 (102 106),
 (103 104).
 II
 « ,
 ()
 XII .,
 XI . (XII .)
 XII .) ,
 XII . »³⁰
 (IV; . 47, 7).³¹
 (112 117).
 XII — XIII .
³²
²⁹ , 102—111 — 10 ., 160—
 200
³⁰
 . 250.
³¹
³² 112—117 — 6 . II; IIg
 ren. Collekcion Zaoussailov, . II, Helsingfors, 1918,

(V; . 47, 9—10).³³
 XII—XIII .
 (VI;
 43, 6).³⁴
 XIII .
 (121).³⁵
 (. 15 16).
 X .,
 XII—XIII .
 (X—XI .,
 (100 125) XII—
 XIII . X—XI .
 (I, II,
 , IV VI),
 (III V, XII—XIII II).
 (II , III, IV,
 V VI).
 (48 127,
).³⁶
 . VIII, 32; . 19/41 . —
 IV
 (Tyszkiewicz . kurchanach na
 Litwie i Rusi zachodniej. Berlin, 1868, . XIII, 3).
³³ 118—119 — 2
³⁴ , 120—122 — 3
³⁵
 (,
 1362 .).
 ()
 (: 1) .

X—XIII . ()

Район или место находки	Типы									Всего
	I	II	IIA	III	IIIA	IV	V	VI	неизвестен	
Старая Ладога	—	—	—	—	—	—	—	1	—	1
Ленинградская обл. (Вруда)	—	—	—	—	—	—	—	—	1	1
Новгород	7	3	—	—	2	—	—	—	—	12
Псков и Псковский район	1	1	1	—	1	—	—	—	—	4
Калининская обл. (Посад)	—	—	—	—	—	1	—	—	—	1
Старая Рязань	—	—	2	—	—	—	—	—	—	2
Средняя Россия	—	—	1	—	—	1	—	—	—	2
Минск	1	—	—	—	—	—	—	—	—	1
Гродно	1	—	—	—	—	—	—	—	—	1
Калужская обл. (Серенск)	—	—	—	—	—	—	—	1	—	1
Вичик	—	1	—	—	—	—	—	—	—	1
Чернигов и область	1	—	—	—	—	—	—	—	1	2
Клев	—	1	—	2	2	1	—	—	—	6
Киевская обл.	—	10	10	12	2	3	1	1	3	42
Полтавская обл. (в границах бывш. Полтавской губ.)	3	—	1	1	—	—	—	—	—	5
Житомирская обл. (Райки и бывш. Овручский у.)	1	—	3	2	—	—	1	—	—	7
Хмельницкая обл. (Городище, Вербична)	1	1	3	1	3	—	—	—	—	9
Дрогобычская обл. (Ступница)	1	—	—	1	—	—	—	—	—	2
Львовская обл. (Подгорцы)	2	—	—	—	—	—	—	—	—	2
Ивано-Франковская обл. (Крылос)	—	—	1	—	—	—	—	—	—	1
Тернопольская обл. (Зеленча)	—	1	—	—	—	—	—	—	—	1
Западная Украина	—	—	—	1	—	—	—	—	—	1
Молдавия (Екимауцы)	1	2	—	—	—	—	—	—	—	3
Ростовская обл. (Цимлянская)	15	4	—	—	—	—	—	—	—	19
Итого	35	24	22	20	10	6	2	3	5	127

16

X—XIII . ()

	Типы									Всего
	I	II	IIA	III	IIIA	IV	V	VI	неизвестен	
Количество	35	24	22	20	10	6	2	3	5	127
Дата	IX (?)—XIII вв.	2-я пол. X—XIII в.	XII—XIII вв.	возможно, 1-я пол. XIII в.	2-я пол. XI—XIII в.	XII—1-я пол. XIII в.	XII—XIII вв.	XIII—XIV вв. (?)	XI—XIII вв.	

II, III IV).

2) 100—101, I, 1—9;

. 1431—1433; I, : 2471, 17

. 1, 1900, 29, . 9—9, 16, . : 2471, 17

2481—2484, 3106). 7

(II, IV VI).

(III IV)

37
 ;
 : «
 », «
 ». 38
 1147 . (. 179).
 : «
 (. , — . .)
 ;
 ». 39
 , 40
 , 41
 (1590 .),
 «
 ». 42
 37
 XIX, ., 1951, . 155 342.
 38
 39
 ., 1908, . 209.
 40
 , . 75. —
 41
 , . 77 . 250.
 42
 , 1863, . 2, ., 1863, . 273.

«
 ».
 (),
 XI . (. Kriegsflgel, Ketten-
 morgenstern, XIV—XV . 43
 (,)
 (). 44 , —

⁴³A. Demmin. Die Kriegswaffen in ihren geschichtlichen Entwicklungen. Leipzig, 1891, . 792—796.

⁴⁴H. Miller. Historische Waffen. Berlin, 1957, . 54—57.

IX—X

III

IX—X

1237—1241

X—XIII

XII—XIII

XIII

XII—

¹ (X—XIII . . .) , 1963, 8—16.



),

X

XII—XIII

) () (

12

XII—XIII

III

XI—

« »

(

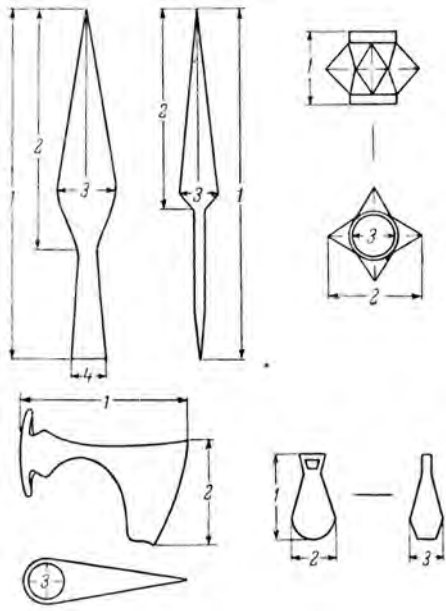

« »
(. 14).

. 14.

IX—XIII

1	2	3	4	5	6	7

							IX—
1—2				1929	1,	I	2-
3				1887	XIII. 2.	I	X 2- X
4		—		1890		I	X
5				1930	6,	I	2-
6		»		1930	V. 17,	I	X X
7				1877	V. 1.	I	X
8—9				1878—1886	VII, 1.	I	X
10		»		1878—1886	VIII, 1.	I	X
11		»		1878—1886	XIX, 1.	I	X
12		»		1878—1886	XLV, 1.	I	X
13—14		»		1878—1886	LVIII, 1.	I	X
15		»		1878—1886	LX, 2.	I	X
16		»		1878—1886	LXV, 1.	I	X
17		»		1878-1886	I , 1.	I	X
18		»		1878—1886	LXXXIV, 1.	I	X
19—20		»		1878—1886	CI, 1.	I	X
21		»		1878—1886	2.	I	X

()

8	9	10	11	12	13	14
---	---	----	----	----	----	----

XI .

25.7—29	13—17	2.6—2.9	2.8—3	. . . 94, . . . , 1934, . 8, . . . II, 8 . . . 9, ESA, t. IV, Helsinki, 1929, . 233—235, t. XXIII, Hel- sinki, 1916, . . . 12 . . . 31. OAK 1899, . . . 107—108.	—	—
48.5	38.5	3	2.7	. . . 94, . . . 30, . X, 7.	—	—
34	27	2.5	2.5	. . . 34, . . . XII, . . . 102.	. . . 35/51a.	—
24	15	2.3	2.3	. . . 107—108.	—	—
26	15	2.3	2.3	. . . 112—113.	—	—
29	21	2.2	2.2	ESA, t. IV, . . . 237—238; FM, t XXIII, . . . 22.	—	—
22	14	2.2	2.2	MAP, 18, . . . , 1895, . . . 98—99; . . . 11. MAP, 18, . . . 99.	. . . 895/5.	—
28	18	2	2.5	. . . 102.	. . . 13/3 .	—
28.5	20	2	2.8	. . . 107—108.	. . . 895/65.	—
28	19.5	2	2.8	. . . 112—113.	. . . 895/13 . . . 14.	—
20.5—24	10.5—15	3.5—2.3	2—3	MAP, 18, . . . 114; . . . 39646,	. . . 895/19.	—
25	14.5	1.8	2.6	MAP, 18, . . . 115.	. . . 13/13 . . .	—
26	15	2	2	. . . 116.	. . . 895/90.	—
32	25	2.5	2.3	. . . 118, . . . XI, 9.	. . . 13/7 .	—
34.5	27	2.8	2.4	. . . 118.	. . . 150/1.	—
19.5—28	12—20	1.8—2.4	2.1-2.6	. . . 124.		—
20.5	16	1.6	1.5			—

1	2	3	4	5	6	7
22			1878—1886	CIV, 1.	I	X .
23		»	1878—1886	CIX, 1.	I	X .
24		»	1878—1886	CXVI, 1.	I	X .
25—28		»	1878—1886		I	X . (?)
29			1909	4.	I	X .
30			1928	6, V.	I	2- X .
31			1910—1911		I	. (?)
32					I	X . (?)
33			1881	10.	I	X .
34—36			1928—1930		I	X . (?)
37			1853		I	X—XI .
38		»	1853	647.	I	X — . XI .
39—40		»	1853		I	X—XI .
41			1895	4.	I	X .
42			1874		I	. 900 .
43			1899		I	X .
			1900		I	X .
45			1960		I	X .
46			1894	5.	I	X .
47					I	X . (?)
48			1900		I	X—XI .
49			1872		I	X .
50		»	1872—1873		I	960-
51			1925	X.	I	X .
52			1957	28 (25).	I	X .
53		»	1957	35 (41).	I	X .
54			1890	220.	I	X - XI .
55			—		I	X . (?)
56—58			1887	00.	I	X .
59			1853	535.	II	. XI .

8	9	10	11	12	13	14
42	30	2.5	1.8	, . 125.		—
23	13	2.4	2.3	, . 126.		—
26	16	2.3	2	, . 129, . XIV, 33.	, . 70/2.	—
21—41.2	13—31.6	2—3.6	2.2—2.4	; , 32, 1953, . 110, I, 3 24.	. 13/13 41/18.	—
38.5	28.5	2.5	2.5	, . XI, . 1915, . 38—39.	, . 1477/1.	—
26	16.5	2	2.5	W. J. Raudonikas. Die Nor- mannen der Wikingerzeit und das Ladogagebiet. Stockholm, 1930, . 44, . 40.	. 700/48.	—
24 18	12 10	1.8 1.8	2.1 2.6	OAK 1911, . 114.	—	—
i 9.5	12.4	1.8	2	MAP, 20, . 1896, . 74, . XVIII, 13.	700/425. , . 150/3.	—
22-44.5	15—27	2.2—3	2.3—3		-967, -1002 -1121.	—
27	18.6	2.1	2.4	, . 15, . 1905, . 93 . 135.	-	—
25.3	13	3	3.2	, 32, . 110, 18.	, . 121/47 .	—
27.5—32.5	10-20	2-2. 2	2.5		, . 121/40 .	—
26	1.6	2.7	2.7	MAP, 25, . 1901, . 107.	, . 23/40 .	—
53	43	3.1	3	, . IX, . 1, . 1881, . 5.		—
23.4	14		2	, . 1, 1899, 106, . 19		—
29	21	2.1	2.5	, . 15, . 106, . 62.	—	—
20 24	12 9.5	2.5 2.1	2.3 3.5	, . 1, 1894, 55, . 24 .		—
38.5	30	2.5	2.6			—
17.5	9.5	1.4	1.9	1892, . XIV, 6. , III-7881.	, . AR-240: 40. —	—
—	—	—	—		(?).	—
35		2.5	3.5	, . 1956, . 118, 4.		—
36	22	2.6	2.4	, . 1916, . 4 . 29, 3343. , v. II, f. 3, Kopenhagen, 1931, . 288, . 3.		—
43 32.3	29 16	3.7 2.6	3.4 2.2			—
	30.5	3.5		, 1908, . 17— 18.	. 918/3.	—
. 30	—	—	—	II. MAP, 1899, . I, 7. MAP, 11, . 1893, . 13 43.	—	—
29	13.7		3.4	I , . , . 1871, . 824.	, . 121/45 .	—

1	2	3	4	5	6	7
60			1853	646.	II	X . (?)
61			1853	667.	II	X . (?)
62		»	1853		II	X - XI .
63			(?)		II	IX—X .
64			1910	51.	II	X .
65		»	1910	72.	II	IX—X .
66			1910	76.	II	IX—X .
67			1878	4.	II	X ft.
68		—			II	X—XI .
69		II.	1888—1900		II	X B. (?) (?)
70			1929	1,	III	2- .
71			1877	V. 1.	III	X . X .
72			1878—1886	VII,	III	X .
73		»	1878—1886	1. LX,	III	X .
74		»	1878—1886	1. LX,	III	X .
75		»	1878—1886	LXIX, 5.	III	X .
76		»	1878—1886	1. CIV,	IIIA	X .
77		»	1878—1886	2. II,	III	2- .
78			1928	6. 14.	III	X .
79		»	1929	6,	III	2- . X
80			1874	VI. 1.	III	2- .
81			1879		III	X . X—XI .
82			1910—1911		III	X . (?)
83			1881	10.	III	X .
84—89			1928—1930 (?)		III	X . (?)
90—93		»	1928—1930		IIIA	X . (?)
94—95		»	1928—1930		III	X . (?)
96			1853	676.	IIIA	X .
97		»	1853	703.	IIIA	X .

8	9	10	11	12	13	14
21.5	10.7	3.2	3.2	.	, . 121/47 .	
13 29	6.2 15	2.6 3	2.6 3.2	I , . II, . 844.	, . 121/47 . , . 70/2.	—
28	14.5	4	3	, , 1893, . 301, 666.	, . 23/53 .	—
16	12	3	2	1914, . 90. XXIV, . 97.	, . 93/12 . , . 93/51 .	
				, . 97.	. . 93/60 .	
22	13	3	2 III—	, . 119/3 .	
—	—	—	—	VI, 1907, . 20—23. , 49, 1955, . 142,		—
18	10.5	2.7	2.5		
22.5	15	3.5	2.3	8. 1899, . VI, , 94, . 7	—	—
29.4	19.5	3.6	3.3	. 1, 4. FM, t. XXIII, . 21		
55	36	3	2.7	. 32; ESA, t. IV, . 237— 238.	, . 150/3.	
39	20	4	2.3	. XI, 8. , . 114.	, . 150/1.	—
26.5	17	3.4	2.2	, . 114.	. 895/64.	
34	24	5	3	, . 116.	, . 150/1.	
29.4	14	3.8	2.8	, . 125, . XI, 6.	—	—
33.5	26.5	4.7	1.8	, . 127—128.	, . 150/3.	—
40.5	26	4.6	2.5	W. J. Raudonikas. Die Nor- mannen..., . 52, . 55.	. 700/199.	
28	20		3	, . 44 . 44.	. 700/63.	
46.7	31	4.2	2.3	ESA, t. TV, . 241, . 2. , . 247.		—
35.4	24	4.2	3	1911, . 114.	—	—
33.5	24.5	5.7	3	MAP, . 20, . 74, . XVIII, 29.	, . 150/1.	—
23—38	13—23	3.6—5	3.3—3.9	.	. -809, -1369, -440, -1446 / . -1120, -1123, -124; -1602. , . -1122	—
20—28	10—15.5	2.8—4.3	3.3—3.6	.		
26—29.5	12—16	3.1—3.4	3	;	/ .	
16.3	10	4.2	3.1	, 1928, . VIII, 1. I , . II, . 844.	, . 121/47 .	
16.5	9	4	3	, . 783.		

1	2	3	4	5	6	7
98			1853	704.	III	X — .
99		»	1853	1081.	IIIA	XI . X .
100—117			1851—1854		IIIA	X—XI .
118			1853		III	X . (?)
119					III	IX—X .
120 -121			1948	6.	IIIA	IX—
122 — 123			1910	28.	IIIA	X . (?)
124		»	1910	37.	III	X .
125		»	1910	50.	IIIA	. X .
126		»	1910	79.	IIIA	IX—X .
127			1910	81.	IIIA	IX—X .
128		»	1910	82.	IIIA	IX—X .
129		»	1910	92.	III	X .
130		»	1910	94.	IIIA	IX—X .
131		»	1910	119.	IIIA	X .
132		»	1910	144.	IIIA	X .
133		»	1910	147.	IIIA	X .
134		»	1910	151.	IIIA	IX—X .
135		»	1910	152.	IIIA	X .
136		»	1910	186.	III	IX . (?)
137		»	1910	206.	IIIA	X .
138		»	1910	218.	III	IX—X .
139		»	1910	232.	III	X .
140		»	1910	239.	III	X .
141		»	1910		IIIA	X . (?)
142—144			1900-		IIIA	X . (?)
145			1878	10.	IIIA	IX—X .
146			1895	12.	III	X .
147		»	1895	15.	IIIA	X .
148—149			1895		IIIA	X .
150					IIIA	X—XI .
151			1898		IIIA	X .
152			1899		III	X .
153			1901	86.	III	X .
154		»	1901		III	X .
155—157			1888—1890		III	X .
158			1932—1939		III (?)	X .
159—160			1956—1957		IIIA	. X .
161			1872—1873		III	960-
162		»	1874 1886	4.	III (?)	X .

8	9	10	11	12	13	14
28	19	2.5	2.3	, . 783.	, . 121/36 .	-
18	8	3.5	3.5	, . 845.	, . 121/53 .	—
15.5—32	8—15	2.6—55	2.3—3.3); , . 15, . 60 . 113.	, . 121/16 , 121/40 , 121/48 , 123/7 , 70/	—
37.5	23.5	3.5	2.9	.	,	,
36	24	3.8	2.1	.	, . 23/57 .	.
12	5.5	2	2	, . 52, ., 1953, . 39, . 10; 11 . 39.	—	
18—22.6	9—14	2.7—3.4	2.6—3	, . XXIV, . 83.	, . 95/27 .	
21	12.5	4.2	3.2	, . XXIV, . 86.	, . 93/5 .	
28	14.5	4.5	3.1	, . 90.	, . 93/7 .	—
16	8	2	2.5	, . 98.	, . 93/35 .	—
20	12	3.5	3.2	.	, . 93/48 .	—
27.5	17	4.2	3.2	.	,	
27.3	15	4	3.8	, . 102.	, . 95/16 .	—
21	12	3.5	3	.	, . 93/40 .	.
26	14	4	3.2	, . 107.	, . 93/17 .	—
24.5	13	4.3	3.6	, . 113.	M, . 95/18 .	—
24.5	13	3.5	3	, . 115—116.	, . 95/37 .	—
23	12.5	3.5	3	, . 116.	, . 95/13 .	—
20	12.5	3.5	2	.	,	
29	14	3.2	3	, . 125—120.	, . 93/36 37 .	—
23.5	13	4.2	3.2	, . 130.	, . 93/57 .	—
36.5	22	4	3.7	, . 132.	, . 93/26 .	—
24.5	14	3.5	3	, . 135.	, . 95/6 .	—
24.5	13	3.5	4	, . 137.	, . 93/44 .	—
26	12.5	3.9	3.1	.	, . 93/38 .	
—	—	—	—	, . XII, □ , 1910, . 2, . 5.	,	
22.5	11	4	3.9	.	, . 23/52 .	
21.5	11	3	3.1	VI, ., 1907, . 32.		
21.5	11	4	2.5	MAP, 25, . 108—109.	, . 23/40 .	—
22—24	11—13.5	3.6 -4	3.6	, . 109.	, . 23/38 .	—
—	—	—	—	, . 49, . 142, □	,	
27.5	14	5	3	, . 1, 1899, 106, . 34 .; , III—7759.	,	
29.5	16.5	5.5	3.1	, . 15, . 122.	,	—
27	14	3.2	3	, . 50—51, . 121.	(?).	—
25.5	12.5	5.5	3.9	, . 69.	,	—
17—21.5	8—13	2—2.3	1.7—2.1	.	,	
—	—	—	—	, . VI, 6, 9 XVI, 15.	,	
—	—	—	—	, . 41, ., 1954, . 13, 9.	,	
25 (?)	14 - ?	—	2.5	, . 34, 4 5. , . 68, ., 1957, . 4 .	,	—
—	—	3.5	—	. 29.	,	—
—	—	—	—	, . 1908,	, . 97/27 .	—
—	—	—	—	. 202.	,	—

1	2	3	4	5	6	7
163			1874—1886	7.	III (?)	X .
164			1925	II.	III	X .
165			1946	6.	III	X .
166			1939	113.	III	X .
167			1893	275.	III	X—XI .
168		»	1894	311.	III	X—XI .
169			1955—1959		III	X—XI .
170			1951	.	III A	X— XI .
171			1949	21.	III	X .
172			1874	1.	V	2- X .
173			1927	.	V	X .
174			1898	34, □	V	X .
175		»	1898	34, □	V	X .
176		»	1898	44.	V	X .
177			1853	580.	V	X .
178		»	1853	1464.	V	X . (?)
179			—	.	V	X . (?)
180			1910	23.		X .
181		»	1910	43.	V	IX—X .
182			1900-	.		X . (?)
183			—	(?).	V	X .
184			1872—1878		V (?)	X .
185			1925	XII.	V	X .
186			1948	, 9.	V	X .
187		»	1958	, 71.	V	X .
188		—	—		V	IX—X .
189			1890	(?), , 218.	V	(?) X—XI .
190		»	1890	, 221.	V	X—XI .
191—200			1951	.	V	X— XI .
201—212			1949—1951		V	2- X— XII .
213			1878—1886	XV, □	VI	X .
214		»	1878—1886	4.	VI	X . (?)
215			1853	.	VI	X—XI .

8	9	10	11	12	13	14
—	—	3	2.7	, . 203; ((?).	□
25.7	16	4	2.5	, v. II, f. 3, 1931, . 32 . 290.	□	—
47.3	32.8	3.5	2	, . 87, ., 1962, . 26, . 10, I.		—
24.5	14.2	5	3.1	, . I, M. — ., 1958, . 182—185, . 29.		—
26	15	3.8	2.4	, . 45.	. 921/3.	—
35	19.5	3	2.5	, . 30.	, . 917/48.	—
28.5	18.5	4.3	3.5			—
25	15.5	5.1	3.5			—
21.5	8.7	2.4	2.8	. 62, 1958, . 157, . 3, 9.		—
29.6	17	2.3	2.8	ESA, t. IV, . 241, . 2.		—
						□
24	13	2.4	3.6	. 29. , . 6, 1941, . VI, 3 . 88.	. 653/154.	—
—	—	2.4	—		, . 125/39 .	□
28.5	18	2.9	2.2	, . 6, . VI, 4.	, . 121/44 .	□
27	13	2.2	3.2	, . 15, . 241 . 146; 2, . 20.		—
—	—	—	—	I , . II, . 790.	—	—
23	13.5	2	2.8		, . 23/59 .	—
—	—	—	—	, . XXIV, . 82.	, . 95/22 23 .	—
26.5	15.4	2	3.5	, . 88—89.	, . 95/38 .	—
		-	-	, . XII, . 6; 7.	—	—
26.5	17	2.1	3	, . 32, ., 1956, . 3, 3.		—
27.	15	2.9	3.5	, . 77—80 . 83.		□
25	13	2	3	, v. II, f. 3, . 45.		—
26	14.5	2	3.5	i i i i i . III, i , 1952, . 128 . II, 8.		—
		2	3			□
23	7.5	1.6	2.5		, . 388155, -68145.	—
		2	3.7		. 924/16.	—
—	—	—	2.5	, . 5. , . 39.	, . 922/3.	—
22—30	12—16.7	1.6—2	2.6—3	, . 50, . 46 . 109.		—
23—35	15—20	2.5	3—3.5	, . 75, 1960, . 187, . 30, I, 2, 5 6.		—
35	16.3	3.2	—	MAP, 18, . 115, . XII, 13.		—
26.5	15.5	3	—			—
26.5	12.5	4		, . 15, . 90.	, . 121/21 .	□

1	2	3	4	5	6	7
216		II.	1853		VI	X . (?)
217			1910	85.	VI	X .
218		(?).	1902 (?)		VII	X—XI .
219			1898	2. 8.	VII	X .
220			1920		VII	X .
221—222			1853		VII	X - XI .
223			1910	2.	VII	I - .
224		»	1910	94.	VII	IX—X .
225		»	1910	98.	VII	X .
226		»	1910	218.	VII	IX - X .
227		»	1910	239.	VII	X .
228			1900-		VII	X . (?)
229			1878	10.	VII	IX - X .
230			1878	13.	VII	IX—X .
231			1895	15.	VII	X .
232			1895	37.	VII	X .
233			1897		VII	IX—X .
234—237			1949—1951		VII	X—XI .
XI—						
238			1930	6.	I	XI .
239			1878—1886	III. XXX,	I	XI .
240			1891	2. 15.	I	XI .
241		»	1891	17.	I	XI .
242		»	1872—1891		I	XI . (?)
243			1904		I	XI . (?)
244			1947		I	XI . (?)
245				(?).	I	XI . (?)
246			1913	9.	I	XI .
247			1901	28.	I	XI—XII .
248			1950—1954		I	XI .
249			1901	60.	I	XI .
250—251			1890-		I	XI .
252			1893	6.	I	XI .

8	9	10	11	12	13	14
32	18.5	3.5	—	.	, . 150/1.	—
23.6	15	5	—	, . XXIV, . 100.	, . 93/54 .	—
11	2	—	2	, III-8370.	—	—
32	12	—	3.1	6, . 87	, . 125/41.	—
20	6	—	3.1	. VI, 5 . 79.	—	—
21—23	3—6	—	2. 5-3	. 12 .	, . 121/40 .	—
—	—	—	—, 1948,	, . 151/3.	—
22	7	-	3.5	. 13.	, . 93/40 .	—
19	—	—	2.7	, . XXIV, . 102.	, . 3/40 .	—
19	7	—	2	, . 103—104.	, . 93/26 .	—
23	7	—	3	, . 132.	, . 93/44 .	—
—	—	—	—	, . 137.	, . 93/44 .	—
23	5	—	2.8	8. . . . XII, . 6,	, . 23/52 .	—
23	5	—	2.8	VI, . 32.	, . 23/49 .	—
29	7	—	3.6	MAP, . 25, . 109.	, . 23/38 .	—
30	8	—	3.3	, . 112.	, . 23/40 .	—
14	6.5	—	—	, . 72, . 1959,	—
18—20	6.5—8	—	3	. 27, 5.	—
				, . 75, . 6, 16	—
				. 146 31, 1 2	—
				. 189.	—

XII

—	-	-	—	, . 94, . 30	-	—
25	16	2.4	3	. X, 6.	, . 118	—
33	21.6	2.7	2.2	MAP, . 18, . 118	,	—
—	—	—	—	. XI, 5.	—
30	16	3	3	MAP, . 20, . 1896,	—	—
43.5	32	3.2	2.6	. 108.	, . 41/32 .	—
33	20.5	2	2.2	, . 32, . 110, 8.	—
—	—	—	—	10021.	, III—	—
—	—	—	—	1893, . XI, .	(?).	—
21.5	16.5	2.3	2.8	. 198.	, 1931, 743,	—
41.5	29.5	3.5	3.5	. V, . 1,	—
24	14	2.6	2	1903, . 51;	—
28.2—41	17—31	2.5—4	2.5-3	III—7878.	, . 15/24 .	—
34.5	20	2.6	2.6	, . XXIX—XXX, 1959,	, . AR-249: 37 ((250).
				. 267, . 4.	250).	
				, . 6, . 1904, . 4.	, . 23612.	
				Wilno i ziemia wile ska.		
				Wilno, 1930, . 16.		
				IX AC, . I, M., 1895,		
				. 170—171.		

1	2	3	4	5	6	7
253	,	.	1938	2, □	I	XI .
254	,	.	1938	11.	I	I- . XI .
255	,	□	1926	4. II, □	I	XI .
256	.	»	1926	7. II, □	I	XI .
257	.	.	1921	11. II, □	I	XI .
258	.	.	1928	22. II, □	I	XI .
259	.	.	1928	24. II, □	I	XI .
260	.	.	1921	2. III, □	I	XI .
261	,	□	1928	1.	I	XI .
262	,	.	1887	8.	I	XI .
263	,	.	1934	2. 2, □	III	XI .
264	.	.	1879	.	.	XI .
265	,	.	1947	8.	IIIA	XI .
266	,	»	1949	2 (149).	III	XI .
267	,	.	1878—1886	XLIV,	IIIA	XI .
268	.	»	1878—1886	3. LVI, □	III (?)	XI .
269	,	»	1878—1886	3. LI , □	III	XI .
270	.	»	1878—1886	2 (?). LXIV, □	III	XI .
271—273	.	□	1878-1886	2 (?).	III	XI .
274—275	.	»	1878—1886	.	IIIA	XI .
276	,	.	1877	2.	III	XI .
277	,	»	1875	56.	III	XI .
278	.	»	1875	1.	IIIA	XI .
279	,	»	1883	40.	III	XI—XIII .
280	,	»	1875	56.	III A	XI .
281	,	»	1876	64.	III (?)	XI—XII .
282	(?),	»	1872—1891	.	III	XI—XII .
283	,	»	1876	36.	III	XI .
284	,	»	1877	.	III	XI—XII .
285	(?),	»	1877	67.	III	XI—XII .
286	,	»	1877	28.	III	XI—XII .
287	,	»	1881	4.	III	XI .
288	,	»	1885	112.	III	XI—XII .

8	9	10	11	12	13	14
—	—	1.5	2.5	Przeł d Archeologiczny, t. VI, z. 2—3, Pozna , 1939, . 195.	-	—
27.5	20.5	1.7	2.3	A	, . 23874. , . 24095.	—
99	8.5		2.5	ii, . 1, , 1928, . 31		—
24	16	2.5	2.3	. VII. , . 37 . IX.	—	—
21.5	—	—	—	, . 41.	—	—
—	—	—	—	, . 253.	—	—
—	—	—	—	, . 255.	—	—
30	—	—	—	, . 48.	—	—
24	15.5	3	1.8	cii, . II, . 1930, . 207— 208, . II . 210. MAP, . 11, . 1898, . 57 . 37.	—	—
20	11	3	3	, 1934, . 2, . 1, 342, . 5—9; , I-14633. ESA, t. IV, . 233.		—
—	—	—	—	, . 1, 134, . 48—50, . XXX. , . 1, 400, . 120.	—	—
54.6	37	7	3.6	MAP, 18, . 107, . XI, 7.	—	—
—	—	—	—	, . 112.	—	—
33	25.5	3.2	2.7	, . 113.	, , . 895/68.	—
36.5	23	4	3	, . 115.	, . 895/67.	—
33—39	22-28	3.6—4	2.5—3		, . 150/1 3, 13/13 ; , . 32, . 110, 2 . 5.	—
39—43 48	21.5—27 34.5	2.7—4 5	2—3 3	MAP, . 20, . 59, . XVIII, 25.	, . 150/1. —	— —
30	19	3	3	, . 61, . XVIII, 26.	, . 150/3.	—
29	20	3.9	2.6	, . 63.	, . 150/1.	—
29.5	18	2.5	3		, . 33/23 .	—
35	20	3.7	2.5	MAP, 20, . 74.	, . 33/15 .	—
24.3	16.5	2	1.5	, . 75.	, . 37/41 .	—
46	38	3.8	3.5		, . 150/3.	—
40	28	3.5	2	MAP, 20, . 76.	, . 37/28 .	—
18	11	2.7	2.2		, / .	—
25	17	4	3.5	MAP, 20, . 84; (. 39648). . 3; 4 . 110. MAP, 20, . 94. , . 96	, . 41/32 .	—
20	12.5	3.3	2.3		, . 37/13 .	—
22.5 41	14 27	3.1 4.2	2.7 2.2	. XVIII, 22.	, . 37/54 . —	— —

1	2	3	4	5	6	7
289		»	1883		III	XI—XII
290		»	1885	20.	III	XI—XII
291		»	1885	5.	III	XI
292		»	1873	4, 2.	III	XI B.
293		»	1873	4.	III	XI—XII
294		»	1874	22.	III	XI
295		»	1891	21.	III	XI
296		»	1881		III	XI (?)
297		»	1885	107.	III	XI—XII
298—303		»	1872—1891		III	XI—XII
304		»	1895	7.	III	XI
305		»	1900	3.	III	XI
306		»	1900	7.	III	XI
307		»	1900	8.	III	XI B.
308		»	1951	17 22.	III	XI
309		»	1901	230.	III	XI
310		»	1900	274.	III	XI
311		»	1900	280.	III	XI
312		»	1900	298.	III	XI
313		»	1900	301.	III	XI
314		»	1900	308.	III	XI
315		»	1900	311.	III	XI
316		»	1908	11.	III	XI
317		»	1908	16.	III	XI
318		»	1911	20.	III	XI
319		»	1961		III	XI—XII
320		»	1930—1940-		III	XI
321		»	1958		III A	XI
322		»	1913	32.	III	XI
323		»	1880-	XIII.	III	XII
324		»	1880-	XLI.	III	XII (?)
325		»	1897		III A	XI—XII
326—327		»	1890—1897		III	XI—XII
328		»	1853	549.	III	XI

8	9	10	11	12	13	14
26	15	2.3	2.2			
25		—	—	MAP, 20, . 99.	, . 150/1.	
45	35	5	1.8	, . 99	, . 40/29 .	-
25.5 (?)	13.5 (?)	3.2	2.6	XVIII, 22.	, . 40/30 .	—
				, . 103		
18	10.5	3	2.1	XVIII, 26; . 1931,		
				734, . 20 (.).		
				MAP, 20, . 106; J. As-		
				pelin. Antiquités du Nord		
				Finno-Ougrien. Helsinki, 1877—		
				1884. N 1136.		
20	13	3	1.5	MAP, 20, . 108.	, . 33/43 .	
35-?	19	2.8	3.2	, . 108	, . 37/24 .	
				. XVIII, 21.		
38	23	2.8	3	, . 1893, . 176—177,	, . 3 VIII/40	
				1399.	31 .	
30	15.6	3.2	3.2	MAP, 20, . 113.	, . 37/45 .	
29—40	18—30	2—5.4	2—3.3	, . XVIII, 24;	, . 41/32 .	
				, . 32, . 110, 4.		
				, . 1, 1894,		
				74, . 15, 24 . 25.		
40	28	4.5	2.6	MAP, 29, . 1903,		
				. 59 . XVIII, 22.	. 856/389.	
45	—	—	—	MAP, 29, . 1903,	—	
				. 60 . XVIII, 22.		
32	25	4.7	2.4	, . 60		
				. XVIII, 26.	. 871/211.	
—	—	—	—	, II-57999.	—	
45	36	5	3	MAP, 29, . 93.	—	
34	25	5.5	3	, . 97.	—	
39	27	3.7	2.5	, . 98.		
35	21	4	2.7	, . 100	. 856/67.	
24	17	2.7	2.9	. XXVI, 4.	. 856/100.	
24	17	2.7	2.9	. XXVI, 2.	. 856/103.	
—	—	—	—	, . 100.	, . 856/129.	
				, . 101.	. 856/131.	
30	20	3.2	2.8			
21	14	2.5	2.7	, . 1909, . 11.		
32	25	5.3	2.6	, . 11—12.		
35	25	3	2.5	, . 1931, 739,	—	
				. 58-59.		
18	12	3.8	3	, . 65, . 1959,	—	
				. 127, 10.		
45	31	5.5	2.8	1959		
—	—	—	—	, . 1931, 743,	(?).	
27	18.5	3.5	3	. 172—173.		
28.6	17	3.5	3			
30	15.5	5	4.1			
28.5—48	15—36.5	3.8—6				
—	—	—	—	I , . II, . 788.	, . 121/45.	

1	2	3	4	5	6	7
329			1853		III	XI . (?)
330			1901	XXV.	III	XI .
331			1857		III	XI .
332			1885		III	X—XI .
333			1938	11.	III	1- XI .
334			1926	2. I,	III	XI .
335		»	1926	I. 3,	III	XI .
336—337			1888	1 23,	III	XI .
338			1880	I. 2.	III	XI .
339			1909	XII.	III	XI .
340				—	III	XI .
341			1890-		IIIA	XI—XII .
342			1890-		II (?)	XI . (?)
343			1948—1949 (?)		III	XI—XIII .
344			1929	2. 6,	IV	XI— XII .
345			1874	30.	IV	XI—XII .
346		»	1883	6.	IV	XI .
347		»	1872—1891		IV	XI - XII .
348			1900	288.	IV	XI .
349		»	1900	350.	IV	XI .
350		»	1901	406.	IV	XI—XII .
351			1908	15.	IV	XI .
352		»	1908	25.	IV	XI .
353			1957		IV	XI .

8	9	10	11	12	13	14
27	17	4	2.3	.	, . 70/2.	—
34.5	20	4	3.2	. 6, ., 1904, . 2—3.	, . 21/1 .	—
37.5	24.5	3	2.5	. 23—24 (.). 1908, . XXI, -693.	. 1890, . 4183.	—
42.2	26	5.6	2.3	.	24096.	—
22.7	14	3.5	3	. I, ., 1928, . 17 . III, 12.	ii,	—
30	16.5	4	2.8	. 46—47 . XI.	—	—
21—31	12—19.7	2. 5-3	2. 2-3	. XIII, . 1, ., 1889, . 147—148.	, . 31/42.	—
16	8.5	3.5	2.5	.	, . 19/57 .	—
24	16	2.9	3.5	. 58. . 1915, . XIII, 2.	-	—
55	46	6.3	3.2	. 122. . 5, 376,	(?).	—
20	13	3.3	—	.	, . 31990.	—
—	—	—	—	. XI . 1899, . 157, 602.	—	—
33	21	4	2.6	. i opii i i i, 1957, . X, 2. . 94, . 17 . VI, 1.	—	—
19	14.3	3.5	2.8	MAP, 20, . 60.	, . 23/17 .	—
23.5	16	3.5	3	. 97 . XVIII, 20.	, . 150/2.	—
21	15.5	3.9	1.8	.	, . 150/1.	—
26	17	3.8	2.8	MAP, 29, . 99, . XXXVI, 1.	. 856/78.	—
27.5	13.5	4.4	2.3	. 105 . XXXVI, 3.	. 856/295.	—
20.5	11.5	3.7	2.2	. 112—113 . XXXVI, 1.	, . 871/42.	—
27.5	13.5	4.4	2.3	.	.	—
27	18	3.8	2.6	. 1909, . 11 . 13	—	—
28.5	16.5	4	2.6	.	.	—
25	19.5	3.3	2.7	.	.	—

1	2	3	4	5	6	7
354			—	—	IV	XI .
355		—	—		IV	XI—XII .
356			1957		V	X—XI .
357			1875	17.	V	XI—XII .
358		»	1874	18.	V	XII .
359		»	1874	44.	V	XI—XII .
360		»	1876	62.	V	XI—XII .
361	()	»	1876 1800	4.	V (?)	XI .
362		»	—	8.	V	XI—XII .
363—365			1947		V	X—XI .
366	()	—	1893		V	XI—XII (?)
367			1880		V	I . (?)
368			1800-		V	XI—XII .
369			1853	677.	V	XI—XII (?)
370—371			1851—1854		V	XI—XII (?)
372			1904		V	XI—XII .
373			1904	15.	V	XI—XII (?)
374		»	1904	22.	V	XI—XII (?)
375		»	1890-		V	XI—XII (?)
376			—		V	XI—XII (?)
377			1898	122.	VI	XI—XII .
378		»	1899	142.	VI	XII .
379		»	1899	365.	VI	XI .
380			1954		VI	XI—XIII .
381			1900	6.	VI	XI .
382			1853	2299.	VI	XI .
383			1938		VI	XI .

8	9	10	11	12	13	14
26	18	3.6	2.8		(?).	┐
17.5	8.5	1.8	2.7	V, 1902, IV, 17.	963.	—
12	6	1.3	2.5		33/57	┐
18	8	1.5	3.5	20, 59	33/46	—
	-	1.3	3	XVIII, 17.	33/51	.
23	14	1.5	2.8	XVIII, 17.	37/41	—
26	16	2	2.3	75.	33/28	—
16.5	—	—	2.3	79.	40/33	┐
12.4	7	1.5	2.8	110.		;
				65, 1959.		1961
				3; 5; 190—191		XI
23	14	1.6	3	III, 1937.	35/52	—
15	9	1.4	2.6	1893, 164, 1216.		—
28.4	17.5	2	2.6	1881, 8.	583/61.	—
30.5	18	2.5	3.5	5, 1,		—
22—24	13—14	1.5—2.2	3.5—4	146.	121/47	—
17.5	8	1.5	2.5	15, 243	23/14	—
27	15	1.9	3	32 (.)	31/43	—
—	—	—	—	32, 110, II.	810/10.	—
				1905, VII, 1, 64.		—
				113		—
				115.		—
	22	2	3	Wilno i ziemia wile ska,		—
				16.		—
				i i		—
				i, 1959, 8, 13.		—
19.5	9.5	4.5	—	MAP. 29, 80	870/209.	.
	—	—	—	57.	808/261.	┐
				83.		—
26.7	16.3	4.6	—	107;		—
	18	4.2	—	III-7351.		.
19.5	13.7	4.2	—	4, 1962, 49, 10.		.
26.5	12	4	—	XII, 1 2,	861/27.	—
35	24	4	—	1901, 214.		—
				22 (.).		—
				Przeł d Archeologiczny,		┐
				t. VI, z. 2—3, Pozna , 1939,		.
				179—181	23765.	.
				II, I.		.

1	2	3	4	5	6	7
384			1878—1886	LVI,	VII	XI .
385			1908	3. 35.	VII	XI .
386		—	1880		VII	XI .
387—390			1952—1953	I. 40, 49. 66	VII	XI .
391			1888—1890	71.	VII	XI . (?)
XII—						
392			1876	9.	III	XIII . (?)
393		»	1877	4 (3).	III	XII—XIII .
394		»	1879	6.	III	XII— III .
395		»	1881	3.	III	XII-XIII .
396			1903	4.	III	XII—XIII .
397		»	1903	5.	III	XII—XIII .
398		»	1900	322.	III	XII—XIII .
399-400			1950 1957		III	III .
401		»	1958		III	XIII— XIV .
402		»	1951 1953		III	XII— III .
403			1938—1940		III	XIII— XIV .
404			1956		III	XII— III .
405			1957		III	XIII .
406			1893	2.	III	XII— III .
407			1894	1.	III	XII—XIII .
408			1951		III	XII— III .
409			1910		III	XII— III .
410—413			1955—1958		III	XII— III .
414—416			1958—1959		III	XII— III .
417			1958—1959		III	XII— III .
418			1932-1939		III	XII - 1- III .
419			1932—1939		III	XII—1- III .

8	9		11	12	13	14
15	6	—	2.4	MAP, 18, 112,	, 13/5 .	.
15.3	8.5		2.2	. XII, 1.		
14	5	—	2.4	. 14 .	, 69/4 .	—
12	4	—	2.5	, 198—199.		
13	4		2.8	, 2, 1957, 262 . XVIII, 2.	. 40/13; 49/9.	
				, XIV, 29.		

XIII

31	24	2.6	2.6	MAP, 20, 77.	, 33/11 .	
20	13	3	2.6	, , 172, 1324.	9. , 70, 1/ ,	—
18	10	1.5	2	MAP, 20, 94.	, 37/57 .	
26	18	2.5	2.6	, 96.	, 37/24 .	—
26	16	2.7	2.3	, VII, 1, ..	, ,	
38	—	—	—	1905, 140 . 85.	. 869/6.	
52	38.5	3.3	3	, 140.	—	—
23.5 - 38	12.5 - 25	2.7—4.6	2—3.6	MAP, 29, 102.	. 856/298.	—
				, 65, .. 1959, 3,	, ,	
40	30	6.5	3	1 126;	. 856/298.	
—	—	—	—	, 4, 2	—	
—	—	3.4	—	. 129.	—	—
—	1.6	1.8	—	, 62, .. 1956,	—	—
33.3	26	4	—	. 113 . 43, 1.		—
20	19	3	2.6	, 32, 110, 15.		—
—	—	—	—	4, 47, 8.		
17.5	14	2.5				
17.5	9	4	2.8	, 1, 1893,	—	—
				101, 10 , 21.	—	—
				, 1894, 51,	—	—
				. 34 . 59 .		
				1957, 2.		
				, III, 3, 1926,		
35	16	1.5—2	2.4—2.7	. IX, 17.		
30.5—58.5	18-46.5	1.6 - 3.5	2 - 2.5	, 92, 1960, 80		
				. 37, 6, 10 11.		
22.5	14	2.7	2.7	, 111, 57,		—
26.5	17.5	2.5	2.5	3, 4 58.		—
—	16	3	—	, 57, 2.		—
				, 41, 1954, 22, 1.		—
				, 22, 2.		

1	2	3	4	5	6	7
420			1881—1888			III XII—XIII . (?)
421			1889	3.	III	XIII .
422		»	1890	3.	III	XIII .
423—424		»	1890-		III	XIII . (?)
425		»	1890-		III	XIII . (?)
426			1957—1961		III	XII .
427			1954		III	XII—XIII .
428			1957		III	XII—XIII . (?)
429			1889 1891		III	1- XIII . (?)
430			1940, 1948—1949		III	XII — 1- III .
431			1887	—	III	XII—XIII . (?)
432—433			1901		III	XII — 1- III .
434					III	XII—XIII . (?)
435			1890-		III	XII — 1- III .
436			1890-		III	II — 1- III .
437		—	1894		III	XII— III .
438			—		III	II- III .
439			1929—1935		III	XII — 1- XIII .
440			1948		III	XII — 1- III .
441—443			1959 1961		III	XII — 1- III .
444		»	1957		III	XII — 1- III .
445—446		»	1957—1958		III	XII — 1- III .
447			1961		III	XII— III .
448			1954		III	XII— III .
449			1883	8.	IVA	XII . (?)
450		»	1876	10 25.	IV	XII— III .

8	9	10	11	12	13	14
26	14	2.8	4	MAP, 4, .., 1890, . 9.		
25.5	19	2.7	2.5	103, . 2 .., 3. 1, 1890,	AR-254: 4.	—
30.3	23	3.7	2.4	, . 22.	AR-254: 22.	—
27	17	3.4	2.5		, . 23499	423
36	25	4.5	3.5		23498.	
—	24	3.2	—		, AR-264: 26.	—
19	9	2.1	1.5			
22.5	11.5	3	1.9	, , I, . 1957, . II, . 271.		
16	—	2.2	1.8	, ., 1956, . 118, 5.		
33	25	3.3	2.5	. 177—178 (. .). 1, 1887,		
30—47	18.5—34	2.5-3.3	2.2—2.8	III-8276. III-8270	433, , . 7927.	—
-	-	-	—	. V, , 1902, . IV, 18.		—
27	20	2.9	2.3		, . 31995.	—
—	—	—	—			—
64	49	3.5	3.5	. XXI, 92. Bro i Barva, Warszawa, 1935, 3, . 53.	1939 .	—
38	20	2.7	3.2	. II, , 1899, . 1, 5. . XII, 3.		
37.6	24.5	4	4	, . III, i i, 1952, . 180, . I, 7.		
46—50	36—38	5—4.8	3.5—3			
41.3	28.5	6	3.7			
31—44	20.5—32	2.5—4	2.7—3			—
26	20	3.2	3			—
26	12.5	3	2.3			—
21.5	14	3	2.6	MAP, 20, . 64 . XVIII, 14.	, . 33/5 .	—
27	17	3.4	3.4		, . 33/41 .	—

1	2	3	4	5	6	7
451			1900	349.	IVA	XII . (?)
452			1955		IVA	XII .
453			1894	1.	IVA	XII— III .
454			1882	1.	IVA	XII—XIII .
455		»	1882	2.	IVA	XII— III .
456		»	—		IVA	XII— III .
457—458			1890-		IVA	(?) XII— 1- . III .
459-462			1890-		IVA	XII— 1- . III .
463					IVA	XII—XIII .
464			1956—1959		IVA	XII— 1- . III .
465			1929—1935		IV	XII— 1- . III .
466			1929—1935		IVA	XII— 1- . XIII .
467			1948		IVA	XII— 1- . III .
468			1959		IVA	
469		»	1957		IVA	XII— 1- . III .
470			1930-		IVA	XII - 1- . III .
471		»	1930-		IVA	XII— 1- . III .
472			—	—	IVA	XII— 1- . III .
473			1951)		V	XII— III .
474			1880-	39.	V	(?) XIII- XIV BB.
475			1896	8.	V	(?) XII— III .
476			1895—1896		V	XII— III .
477			1905		V	II- III .
478			1961		V	XII—XIII .
479—480			1957—1961		V	XII—XIII .

8	9	10	11	12	13	14
25	14.5	3.1	3	MAP, 29, . 105.	856/294.	—
40	27	5	3.8	. 129. 65, . 4, 1		□
26	17	4	3.5	. 1901, . 425. . V,		—
29	14	4.2	4	, . 318—319.	, . 35/37 .	□
42	27	5	4	, . 319—320.	, . 35/38 .	—
40—49	18—31	3.5—6	4.6	. 183 (. 49, . 142 .)	. 69017	458 —
30—39	20—25	5—6			68412.	
28.3	18	3	3.5	, 1898, . 18—19, 773—776.		—
27	18	2.7	3		. 741/766.	—
26	15.5	3	3.5	, . XII, 4.		□
52	35	6	4.5	. 27. . XII, 1	. 463.	□
40	30	7	5			□
22.5	12	3	2.1			□
43.5	26	5.5	4			□
49				. i — i , 1944, . 183.		□
38	25.5	4	-	. i i . . X,	, . III-170.	□
18.5	12	2.5	2.5	1.		—
	—	—	—			—
45	35	2	3.3			—
28	20	1.5	4	1901, . 354; . 1, 1896, . 55 (.), . 20.		—
17	8	1.5	3		. 1044/62.	—
—	—	—	—	. VIII, . 1, . 1906, . 195.	—	—
19	8	1.2	2.7	. 1962, . 241—		—
18—21	11.5	1.2	2.5 - 3.9	242.		480

1	2	3	4	5	6	7
481			1880-	4.	V	XII .
482—483			1940, 1918—1949		V	XII—XIII .
484		»	1958		V	XII—XIII .
485			1934—1937		V	XII—XIII .
486—490			1901 1949		V	XII— 1- . XIII .
491—510			1890-		V	XII— 1- . XIII .
511			1893	271.	V	XII—XIII .
512		»	1895	335.	V	XII—XIII .
513		»	1892	261.	V	XII—XIII .
514		»	1892	262.	V	XII—XIII .
515		»	1893	320.	V	XII—XIII .
516		»	1894	323.	V	XII—XIII .
517			1892	1.	V	XII—XIII .
518			1897	53.	V	XII—XIII .
519			1860	9 (4).	V	XII—XIII .
520			1894		V	XII—XIII .
521—523			1956—1959		V	XII— 1- . XIII .
521			1946		V	XII—XIII .
525—538			1929—1935		V	XII— 1- . XIII .
539—556			1957—1962		V	XII— 1- . III .
557—558			1890-		VII	XII— 1- . III .
559			1929—1935		VII	XII— 1- . III .

8	9	10	11	12	13	14
22	11	2	3.5	, . 132, 834.	, . 31/33 .	□
18-26	10—16	1.5—2	2.8—4.5	.	,	—
21	13.5	1.5	1.8	.	.	—
22	12	1.6	3.4	i, . III, ÿ,	—	□
19.5-20.2	11	0.9—1	2.2—3.5	1950, . 81 . V, 5. (410, 415 /); III-8276 i i . V, . 6 . 155.	, (?)	.
25-30	15-17	1.5	3	. XXXVI, 1892, . 100; , 1893, . 109, 81; , 1898, . 19, 782— 788.	12 31986— 31988, 31992, 31994, 32794, 32849—32852, 32854; 3 —	(32794).
20	14	1.5	2.5 44 (.); 62, . 162, . 9, 2.	. 913/8.	—
21	12	1	3.4	, . 15.	, . 926/1.	—
25	13	1.6	3.5	1959, . 219—226, . 4, . 220, . 1	.	—
19.2	10	1.4	3.1 70—71.	. 90 1/3.	—
20	9.5	1.8	3.7	, . 78.	, . 901/26.	—
22	16.5	1.3	3	, . 87—89.	, . 898/58.	□
19	11	1.5	3 □ , 1902, . 54, 132.	, . 904/9.	.
42	28	1	3.6	, 62, . 19 . 184.	—	—
24.2	15	1	3.5	—	□	—
23.5	16	1.5	3	.	. 935/15.	—
20	13	1.7	3-4.5	.	.	—
30	20	1.1	3.6	, 1960, . 133, . 5, 5.	.	—
16—19	6.5—27	0.7—2	3—4 XII, 5— 7; □	5 459, 462 / ; 2 . 56 . 57; . 151/1.	□
22.5—29	14—19	1—1.5	3.2—4	.	.	□
12—35	4.5—6	—	3	.	. 32842	.
29	6.5		3	.	32857.	.

IX—XIII . ()

1	2				6	7
		3	4	5		

IX—XI .

I			1877	2.	X—XI	ESA, t. IV, Helsinki, 1929, . 239.
II			1878—1886	.	X	MAP, 18, ., 1895, . 114 .
III			1910—1911	1.	X	XV , . I, M., 1914, . 415.
IV			1910—1911	.	X	, . 421.
V			1870-	2.	X	1874—1876, 1—12, ., 1876, . 97.
VI—X			1928—1930 (?)	.	X (?)	-
XI		PL	1898	39, □ 1.	X	, 6, 1941, . 88.
XII			1913	1.	X	, . . . 2693.
XIII-XIV			1851—1854	.	X—XI	, . . . 17, 266/2, . 55 ; I , . II, ., 1871, . 846
XV—XVII			1910	150 187.	IX—X	, . XXIV, 1914, . 116
XVIII			1878	13.	IX—X	127. , . 23/49 .
XIX—XXII			1881, 1885, 1900 1949	□	X	, 1, . 1; . 1893, . 95, 137; , . 15, . 1905, . 68—69; , . 1, , 1952, . 328—329.
XXIII— XXXII			1872—1873	.	960- □ □
XXXIII		»	1872	II.	X	1916, . 4 . . . □
XXXIV— XLIII			1862	8, 103, 104, 105, 111, 115, 117, / « ».	X	XIV . ., 1916, . 6—12. I, . . ., 1958, . 128, 142 .; , . 2, , 1888, . 247— 248.

1	2	3	4	5	6	7
XLIV			1893	276.	X—XI	1908, . 46.
XLV		»	1895	337, □	X—XI	, . 78.
XLVI		»	1892	1. 266, □	X	, . 81.
XLVII— XLVIII		»	1897—1898	1. 400 415.	X	, . 111 112.
XLIX		□	1925		. 1000	Rocznik Wołinski, t. III, Równa, 1934, . 71—72.
L			1923		X— XI . (?)	, . CLIV, i , 1937, . 204.
LI—LIII		□	1949—1951		IX—X	, 75, 1960, . 140.

XI—XII

LIV		□	1929	6,	XI	, . 94, . 17.
LV		□	1878	2. 2.	XI	ESA, . IV, Helsinki, 1929, . 236.
LVI			1947		XI	, . 1, 154, . 236, . 23.
LVII		»	1947	1 (12).	XI	, . 55.
LVIII		»	1949	2.	XI	, 400.
LIX			1910—1911		XI	XV , . I, . 415—416.
LX			1910—1911	3.	XI	, . 416.
LXI— III		□	1873—1885		XI—XII	MAP, 20, ., 1896, . 57
XCIV		□	1879	1.	XI—XII	. III, ., 1880, . 34—35.
XCIV			1879	2.	XI—XII	, . 36.
XCVI		—	—	(?).	XI—XII . (?)	, . 164.
XCVII		□	-		XI—XII . (?)	
XCVIII-C			1872		XI	1903, . 513.
CI			1881		XI . (?)	, . 420—421. , . XLIX, . 3, ., 1886, . 200.
II			1883		XI	, . 5, ., 1886, . 694.

1	2	3	4	5	6	7
III- CXXXII			1852—1854		XI—XII	I . . . 8, 2, . 44 . . ; II, . . 1871, . 811
CXXXIII		II.	—		XI	. . . 43/35 .
CXXXIV			1892	4.	XI	. . . 1, 1890, 207, . 100 .
CXXXV— CXXXVI			1900	4 6.	XI	. . . 1900, 139, . 21 .
CXXXVII			1857		XI	. . . IX, . 1 2, 1897, . 260.
CXXXVIII			1860 (?)		XI	1903, 7, . 232—233.
CXXXIX		»	1872	2, . . .	XI 161.
CXL			1877	3.	XI ii, . I,
CXLI— CXLII		—	1890	3 (4).	XI	. . . 1928, . 49 51.
CXLIII		—	1890	3 14.	XI	VII . . . 1890, IX, . 5—6.
CXLIV			1890	1.	XI 6.
CXLV		»	1890	34.	XI 1, 1890, 32, . 41 .; . . . 31/39 .
CXLVI			1890	59.	XI 1, 1890, 32, . 44; . . . 31/39 .
CXLVII			1912	40.	XI 1, 1912, 116, . 39.
CXLVIII			-		XI— XII XI 1899, . 129, 1520.
CXLIX			1887	8.	XI—XII	MAP, 11, . . 1893, . 35 37;
CXLIX CL		»	1887	58.	XI 43 46.
CL			1893	283, . . .	XI—XII 84.
CLI			1897	2.	XI XI . . . I, M., 1901, . 517;
LII CLIII			1897—1898	1.	XI 563.
			1899	433.	XI 168; . . . 949/49.

1	2	3	4	5	6	7
XII—XIII .						
CLIV- CLXIII	(1876—1881		XII—XIII	MAP, 20, . 72
CLXIV- CLXV)		1882	5 7.	XII—XIII	1883, 66, . 7-8.
CLXVI CLXVII			1898 1898	20. 5.	XII—XIII XII—XIII	. 9. . V, 1901, . 414.
CLXVIII		—	—		XII—XIII	49, 1955, . 142 (
CLXIX- CLXX CLXXI— CLXXII			1890	4 6.	XIII (?) XIII (?)). . 1, 1890, 103, . 22
CLXXIII— CLXXV CLXXVI CLXXVII			1888-1889	8 10.	XII—XIII	, 1889, 43, . 114
CLXXVIII— CLXXX CLXXXI CLXXXII	(1888-1889	4.	XIII . (?)	, . 1, 1889, 43, . 115.
CLXXXIII CLXXXIV)		1889 1888	18. 16.	XIII . XIII .	, . 117 , . 120—120
CLXXXV CLXXXVI CLXXXVII			1907 1909—1911		XIII . XIII .	, . XXV, ., 1956, . 324.
CLXXXVIII CLXXXIX			1871		XII—XIII	, ., 1911, . 63—64.
CLXXX			1888		XII—XIII (?)	, ., 1895, . 51.
CLXXXI			1893	283.	XII—XIII	, 1896, . 102—103.
CLXXXII			1887	« ».	XII—XIII	. 184.
CLXXXIII- CLXXXV CLXXXVI		—	1874		XII—XIII	, 1899, . 103—104, 498—500. , . 106—107, 604;
CLXXXVII			1877	3.	XII—XIII	, ., 1908, . 225.
CLXXXVIII			1929-1935		XI — 1- XIII XII — 1- III	; , 1950, . 92.
CLXXXIX— CXC						

1	2	3	4	5	6	7
1—2	,		1930	V IX. 1,	III	2- X
3	,		1878—1885	LXXXVIII, 1.	IVA	X
4	,	(?).	1902 ?		III	X
5	,		1953		II	X
6	,	»	1947—1956		III	X
7	,		1854	12 (?).	III	X
8	,		1910	105.	III	X
9	,		1895	26.	II	X
10	,		1899	43 (32).	IVA	X
	,		1949	5.	III	X
12—13	,		1888—1890		III	X—XI
14	,		1877	8.	III	XI—XII
15	,	»	1879	9.	III	XI—XII
16	,	»	1874		III	XI—XII
17	,		1899	I, 4.	IVA	XI
18	,		1879	1.	III	XI - XII BB.
19	,		1899	147.	IVA	XI
20	,		1904		III	XI- XII
21	,		1947		III	XI
22—23	,		1929	20.	IVA III	XI
24—25	,		—		III	XI - XII BB.
26	,		1957		III	XI—XII
27	,		1928	18. II, 1.	III	XI
28	,		1928	23. II, 1.	III	XI
29	,		1950 1954		III	XI—XIII
30	,		1909	14.	IVA	XI

()

8	9	10	11	12	13	14

X .

14	4	2		1934, . I, 11; II, 1. 94,		1 —
26.5	9.5	2.9	—	MAP, 18, ., 1895, . 119.	, . VIII-13/5a.	—
11.5	6.5	3	—	, III-8370.	—	—
15.2	11	3.3	1.6	, 65, . 4, 8.		
18.5	11	3.5	—	. 127, . 4.	—	—
20.5	11.5	5	—	I, ., II, ., 1871, . 830.	, . 121/24 .	—
13	6.5	2.4	1.6	, . XXIV, .,	, . 93/55 .	
14	7	3	1.5	1914, . 105.		
	9.5	2.5	—	MAP, 25, ., 1901, . 110.	. . 23/38 .	
				. 15, . 39	, . 117/10 .	
12	7	4.5		. 101.		
				, 1952,		
17	8.5—11.5	3.2—3.7		. 2.		
					
				., 1899, . VI, 7		
				XIV, 22.		

XI—XII .

17	12	3.5	 1893, . 180, . 1453.	, . VIII/40/26 .	
19.6	11	3	—	MAP, 20, ., 1896, . 88 . XVIII, 23.	—	—
22.5	13	4.2	—	, . 170, 1303.	, . 150/3.	—
14.6	7		—	, II-26303.	. 692/7.	—
17.5	10.5	2.2		, . III, ., 1880, . 20—21.		
19	10.5	3.2		MAP, 29, ., 1903, . 84		
20	14	3	—	II-26224.		
16	8.5	2.5		3, . 166.		
	10	1.8-2.4		, 1961, 1, . 203	. 2105/3.	—
				. 2 . 206.	. 2105/3. (?)	
15-18.5	9—12	2.5—4	—	. 1, . 16; 17, ., 1930, . 29		
25.5	11	1.9		, . 46, 12 81, ., 1960, . 98.		—
16.5	10	4	 i,	-	—
16	9.5	4.6	—	. I, ., 1928, . 89		
17	9	3	—	. XVII, 3.		
17.5	10.5	2.7		. XIX, 1, . 254	-	—
				. XXIX—XXX, .,		
				1959, . 16 . 278.		
				., 1915. . XIV, 2.		

1	2	3	4	5	6	7
31-32	.	.	1947—1956	.	III	XII—XIII
33	,	.	1800-	29.	IVA	XII—XIII
34	.	.	1936—1940	.	III	XII—XIII
35	,	.	1910	.	III	XII— III
36	,	.	1958	.	III	XII—XIII
37	.	.	1957-1961	.	III	XII .
38	.	.	1932—1939	.	III	XII— 1- XIII .
39—40	,	.	1961—1962	.	II	II- III .
41	,	.	1957	.	II	XII— 1- XIII .

X—XI .

I	.	.	1872
II	.	»	1872—1873
III	.	.	1926
IV—V	.	.	1909
VI	.	.	1897

X —

1	2	3	4	5	6	7
---	---	---	---	---	---	---

1	,	.	1878—1886	XLV,	I	. 1000 .
2	,	»	1878—1886	4. LXV,	I	X .
3	,	»	1878—1886	4 CXVI,	I	X .
4	,	.	1853	1 893.	I	X .
5	.	»	1853	941.	I	X .
6	.	.	1853	1085.	I	X .
7	,	»	1853	676.	I	X .
8—11	.	»	1853	.	I	X—XI .

8	9	10	11	12	13	14
---	---	----	----	----	----	----

XII—XIII .

18	11	3.8—4		, 65, 1959, . 127, . 2 (4 5), . 4, 9 . 129.		
20	12	3.5	—			
—	—	—	—			—
25	14	3.8				
11	6	1.5	1.5	1926, . IX, 18. III, . 3, . 92, 1960, . 57, 1.		
—	10.5	—	—			
15	9.5	4		, 41, 1954, . 22, 3.		—
15.3	4	1.6	1.5			
—	10	4.5	—			

()

				X .		, 1908,
				960-		. 195—197.
	34.			X		. 197—201.
1	5.			XI		, . I. M. - , 1950, . 147.
10.				XI		, . 1915, . IX, 5 XI 4.
				XI		, . I, M., 1901, . 517.

XIII . ()

8	9	D	11	12	13

X — XI .

11	4	2 2		, 18, ., 1895, . 108.	, . 41/27 .	—
11.5	4.5	1.8 1.8		, . 145, . XIII, 2.	, . 13/4 .	—
14.3	4.7	2 2		, . 129, . XII, 11.	. 70/2.	—
20	5	2.7 2.7		I , . II, ., 1871, . 783, 797.	, . 25/51 .	—
18	4.5	2.5 2.5		. 845, 791;	, . 121/17 .	—
14.7	4	2 2		. 15, ., 1905, . 113, . 137. I , . II, ., 1871, . 845, 786.	, . 121/18 .	
15	5	2.3 X 2.3		, . 844, 853.	, . 121/47 .	-
11.5—21	4—6	2.3—3.7 2. 6			, . 123/1 ; , 39636.	

1	2	3	4	5	6	7
12—14			1851		I	X—XI
15			1851 — 1854		I	X—XI
16			1910	81.	I	X
17		»	1910	215.	I	X
18			1890-		I	X
19			1950	65.	I	X
20			1950	66.	I	X
21			1885	1.	I	X
22			1872		I	X
23		»	1874	II.	I	X
24		»	1874 1866	7.	I	X
25			1888	188.	I	X
26		»	1897	400.	I	X—XI
27			1882	1.	I	. 1000
28			1882	2.	I	X—XI
29			1951		I	X—XI
30-31			1951		I	IX—X
32			1878—1886	X,	II	X
33		»	1878—1886	4. CXVI,	II	X
34			1955	8.	II	X
35			1897	10.	II	2- X
36			1872	1.	II	X
37			1928—1930		II	X - ?
38			1853	1022.	II	X
39		»	1853	1187.	II	X— XI
40		»	1853	1430 (?).	II	- I
41		»	1853	1440.	II	X - XI
42		»	1853	1490.	II	X
43		»	1853	1535.	II	X—XI
44		»	1853	2083.	II	X
45		»	1853—1854		II	X . (?)
46			1900-		II	X . (?)
47			1960		II	X
48			1890		II	. 1000
49			1890 (?)	—	II	- I
50			—	—	II	X - XI

8	9	10	11	12	13
12—14	3-4.5	2.3—2.5 2.3—2.5	, . 15, . 78; 103; 109.	50/1. , . 121/26	□
24	5	—	, . 110.	—	—
13.5	5.3	—	, . XXIV, .. 1914, . 98.	, . 93/48 .	.
17	5	3.3 3.3	, . 131.	, . 93/15 .	—
—	—	—	MAP, . 28, .. 1902, . 25, . 75.	—	—
15	3.7	—	, . 44, .. 1952, . 27, 3.		—
16.5	4	—	, . 27, I.	.	—
11			.	.	
15	4		. III—VI, .. 1907, . 68 71.	.	
13.3	4.4	2.1 2.1	. 36 .. . 54. , . 86—87, . 90.	(?).	—
14.4	4		, . 82.	—	
14	4.2	—	.	□	
19	5.5	—	.. 1908, . 197. , . 111.	944/4. , , , 923/1.	.
14.5	3.2	2.3 2.3	P. Paulsen. Axt und Kreuz..., Bonn, 1956, . 43, . 13.	□	—
14.2	3.2	2.3 2.3	. 43, . 13.	.	—
13.5	4		, . 50, 1953, . 45, 2.	.	.
11.5—14.5	2.5—4.8	1.8 2.3 2.3 2.3	, . 75, 1959, . 4; 8 10, . 142.	.	—
16.6	8.7	2.5 2.3	MAP, 18, . 100, . XII, 4.	, . 14/11 .	—
17	11	2.5 2.1	, . 129—130.	, . 41/27 .	—
12	12	2.5 2	, . 65, .. 1959, . 5, I, . 133.	.	.
14.5	12	2.5 2	, . 6, .. 1941, . 87.	, . 125/40 .	—
12.5	10.4	2.2 2	SMYA, t. 1. Helsinki, 1874, . 6, . 29.	.	2 □
12.7	8	2.5 X 2	-	□	—
13.2	8.6	2.7 2.2	. I , . II, .. 1871, . 783, 784.	, -1135. , . 25/51 .	—
12.1	6	2.3 2	, . 783, 795.	, . 121/53 .	—
15	8	2.5 X 2.3	III . .	, . 121/18 .	
16	11	3	, . 15, . 118, . 137.	,	.
20	8	2.5 2.3	, . 114, . 137.	.	—
16	9.7	2.5	I , . II, . 783, 784.	, . 121/21 .	
17.5	10.7	3 2.5	, . 15, . 116, . 137.	, . 121/19 .	.
14	7	2.7 2.1	III . .	, . 121/24 .	—
—	—	—	1910, . VI, 4. . XII,	(?).	□
18.5	8	2.2 2.2	.	.	—
15	8	2.6	III . .	, . 52/3.	.
21.5	6	—	P. Paulsen. Axt und Kreuz..., . 36, . 12, , . 45, . 14.	□	□

1	2	3	4	5	6	7
51			1872-1878		II	X .
52		»	1874	1.	II	X .
53	(1952	17.	II	X .
54)		1946	6.	II	X .
55			1900		II	X .
56			1934		II	X—
57			1951		II	X—XI .
58			1929		III	IX—X .
59			1878	29.	III (?)	X .
60		VII	1887		III	X .
61			1928—1930		III	X . (?)
62			(?) 1852	66.	III (?)	X—XI .
63			1853	708.	III	X .
64		»	1853	925.	III (?)	X .
65		»	1853	1083.	III	X .
66		»	1853	1568.	III	X— XI .
67			1851—1852	4.	III	X—XI .
68			1851—1852	13.	III	X—XI .
69			1851		III	X—XI .
70			1851		III	X—XI .
71—73			1851—1852		III	X—XI .
74—84			1851—1854		III	X—XI .
85			1899	4.	III (?)	X .
86			1905	17.	III	X .
87			—		III	X .
88			1956	22.	III	X .
89		»	1957	52 (51).	III	X .
90			1939	86.	III	X .
91		»	1939	113.	III	X .
92—93			1951		III	X—XI .
94			—	—	IV	X - XI .
95		(?).	1902 (?)		IV	X—XI .
96			1853	556.	IV	. 1000 .
97		»	1853	581.	IV	X .
98		»	1853	589.	IV	X—XI .
99		»	1853	1081.	IV	X .
100		»	1853	1471.	IV	X .
101		»	1853	1543.	IV	X—XI .
102		»	1853	1547.	IV	X—XI .

8	9	10	11	12	13
15.5	6.5	2.7, 1916, . 17 83.	(?).	—
16.5	10.5	2.7 82, . 86.	.	—
12.5	9.5	3 1.7	—
22.5	10	3.5 2.3	—
18	15.7	3.5 1.8 VII, . 1, 1905, . 143 90.	—
14	8	2.8 1.5 III-141.	—
14.5	6.8	2.7 50, . 45, 2.	.	—
10.5	5	— 1948, . 82, . III, 2.	.	—
13	—	— XXXV, . I, . 2, 1878—1879, . 68.	—	—
12	5	2.5	.	.	—
12.5	4	2 2	.	.	—
-	—	—	.	.	—
10	4	2 2 1907, . 47, 532. I II, . 844, 806. 121/36 .	—
12	4.5	2.5 2.5 803. 121/17 .	—
13	5.3	2.5 2.5 784. 121/53 .	-
11.8	4.2	2.3 2.3 836, 792. 121/44 .	.
10	3.7	1.2 121/30 .	—
10.1	4	2.2 46, . 40. 123/14 .	.
10	2.8	2 2 46, . 40. 121/23 .	—
11.7	5.1	2 2 15, . 397, . 157.	—	—
9—13.8	4—4.8	1.5-2 121/42	.
9—12	3-7	1.5-2 1.8—3.2 2.2-2.7	.	123/7 . 123/1	6
13	5	2.5 2.5 I, . 1, 1909, . 9. VIII, . 1, 1906, . 188, . 30.	.	—
12	5	2 2 i i ii, . II, 1930, . 280, . II, 3.	.	—
12.3	5.5	2.5 2.5	.	.	—
12	5	2.6 2.6	.	.	—
12.6	3.5	2.5 2.5 I, 1950, . 153—154, . XII, I, 182 29.	.	—
11	4	2.2 2.2 50, . 45, 2.	.	—
14.5	4.8	—	.	.	—
12.5	8.2	2.1 2.1	.	.	—
11.5	5	2.3 2.3 III-8370.	885/9.	—
9.5	5	2 2 I II, . 800, 804. 121/47 .	.
9	4.2	1.8 1.8 844, 805.	.	—
12.5	6	2 2 784, 857.	.	—
11.5	6.5	2.3 2.3 845, 796. 121/53 .	—
14.6	9	2.5 2.5 785, 879. 121/33 .	.
13.5	7	3 3 783, 779. 121/44 .	.
3	7.5	2.4 2.4 783, 778.	.	—

1	2	3		5		7
103—118			1851—1854			IV X—XI
119			1896	4.		IV X
120			1900	65.		IV X
121			1900			IV X
122			1900			IV X
123			1950	56.		IV X
124			1913	1.		IV (?) X
125			1872—1873			IV X
126			1958	73 (119).		IV X
127		»	1958	76 (112), 1.		IV X
128—130		—	—	(?).		IV X—XI (?)
131			1951			IV X—XI
132			1929	1,		V 2- X
133		»	1929	1,	III.	V 2- X
134		»	1929	1,	V.	V 2- X
133		»	1929	4,	XII.	V 2- X
136		»	1929	7,		V I. X
137			1878—1886			V VIII, X
138		»	1878—1886	1.		V XLV, X
139—140		»	1878-1886	1.		V LVIII, X
		»	1878—1886	1.		V LX, X
141		»	1878—1886	5.		V LXI, X
143		»	1878—1886	1.		V LXV, X
144		»	1878—1886	1.		V LXXXIX, X
145		»	1878—1886	1.		V . 2. X
146		»	1887--1886			V CI, X
147		»	1878—1886	10.	I.	V CXVI, X
148			1928	6,		V I. X
149		»	1928	6,		V X
150		»	1928	6,		V V. X
151		»	1928	14.		V X
152			1928			V X
153—155			1878—1886			V X
156—161			1880—1890			V X (?)

8	9	10	12	12	13
8. 5—15	6. 3—9	1. 8-3 1. 8-3	III	52/1, 18/3, 121/1 , 123/1 ;	6
15. 3	9. 5	3 3 117/47 .	—
15	9	3 3	, . 15, . 60, . 82.	—
14. 5	9. 3	2. 8 2. 8	III	, . VIII-11/III-9.	—
15	9. 5	3 3	—
11. 8	7	2. 3 2. 3 44. . 27, 2.	—
—	—	—	. 107. 1, 1912, 192,	—	—
11. 5	7. 7	2. 3 2. 3	—
12. 5	7. 5	2. 3 2. 3 4 34.	—
14. 5	9. 3	2. 5 2. 5	—
10—13. 5	7—10	2-2. 6 2-2. 6 V, 1902, . III, 14, 14 , 13.	(?).	—
12	8. 5	2 2	—
13. 5	5. 2	— 94, . — 1934,	—	—
13. 5	6. 5	—	. 7, . I, I, 7, . I, 7.	—	—
11. 8	6	2. 5 2	, . 9.	—	—
13. 8	6	3 2. 3	, . 22.	—
11	5	2 1. 5	, . 22, . VIII, I.	(?).	—
13. 5	6. 5	3 2. 5	MAP, 18, . 99.	, . 13/3 .	—
13. 8	6	—	, . 107—108.	, . 41/19 .	—
11 - 12	5—6	2. 5-3. 3	, . 112—113.	, . 13/5 ;	—
14. 5	7	1. 7-2 3. 8 2. 3	, . 114.	, . 895/12.	—
15. 5	8	3. 3 1. 8	, . 114.	, . 41/28 .	—
14. 7	7	3 1. 8	, . 115.	895/33. , . 41/28 .	—
10. 6	5. 5	2. 7 1. 5	, . 119.	, . 895/25.	—
11. 5	5	2. 7 1. 5	, . 123.	, . 13/7 .	—
15. 5	7. 7	3. 5 1. 7	, . 123—124.	, . 150/1.	—
8	3. 5	1. 6 1. 2	, . 129—130.	, . 40/10 .	—
13	7	3 1. 5	W. J. Raudonikas. Die Normannen der Wikingerzeit..., Stockholm, 1930, . 43.	700/424.	—
12. 8	5	3 1. 3	, . 44.	, . 700/39.	—
14	10. 5	3. 3 1. 8	, . 44, . 40.	, . 700/49.	—
13. 8	7. 5	3 1. 5	, . 52, . 55.	, . 700/49.	—
12	7	—	OAK 1914 . . 114 (.) .	(?).	—
12. 6— 14. 5	6—7. 5	3. 5 1. 7	III	, . 41/21 , 41/27 , 13/10 .	—
11. 2— 14. 8	6—8	2. 8—3. 4 1. 5 - 1. 7	, . 895/35, 36, 43, 46, 57, 59.	—

1	2	3	4	5	6	7
162			1950-		V	X
163			1853	1576.	V	X - XI
164—166			1851 — 1854		V	X (?)
167		—	-	—	V	
168			1878—1886	2. CV,	VI	X
169			1928—1930		VI	X
170			(?) 1853	535.	VI	XI
171		»	1853	647.	VI	X—
172—175			1851—1854		VI	1- X—XI
176			1899	50.	VI	X
177		»	—		VI	X
178			1928	6,	VII	2- X
179			1876-1886	VI. XCV,	VII	X
180		»	1876—1886	. 1. LX,	VIII	X
181		»	1876—1886	1. LXXXIX,	VIII	. 1000
182		»	1876—1886	. 2. II, . 4.	VIII	X
183			1909	4.	VIII	X
184			1853		VIII	X—XI
185—188			1851 — 1854		VIII	X—XI
189			1910	178.	VIII	X
190			1929	VIII. 1,		2- X
191		»	1929	I . 1,		2- X
192			1878—1886	4. IX,	I	XI
193			1903	8.	I	XI
194			1874		I (?)	XI
195			1881	16 (33).	I	XI
196		»	1881	20 (37).	I	XI
197			1955	(?).	I	XI—XII
198			1853	1439.	I	XI
199—200			1851—1854		I	XI
201	(?).		—	—	I	1- XI
202	(?).	—	—		I	XI—XII
203			1926—1927	1 (3).	I	XI

8	9	10	11	12	13
12 10	6 3.5	3.2 2.2 2.3 2.3	, 65, . 25, . V. . I , . II. . 788, 790.	, . 121/44 .	—
8.5—12.5	3—8.5	1.8-3 1.8—2.3	III . . .	, . 52/1, 123/1 ,	—
13.6	9	— V, . III, 13 .	, . 41/27 .	—
14.5	7.8	3 2.2	MAP, 18, . 125.	, . 121/45 .	—
11	6	2.5 2	- - - - -	- - - - -	- - - - -
14	7	3 2.6	. I , . II, . 824, 802.	, . 121/47 .	—
10	5	2.2 1.8	III . . .	, . 123/1 .	—
13—14.5	6.2—8	2.3-3 2.3—2.6	, . 18/3, 52/1,	—
13.2	5.4	2.8 2.5	, . 15, . 92, . 61.	, . 700/66.	—
14.5 18	9.2 14.5	3 1.3 3.3 2.5	III . . . W. J. Raudonikas. Die Normannen der Wikingerzeit..., . 44, . 44.	(?).	—
17.2	12.5	3 2.4	MAP, 18, . 122; , . 21584.	, . 150/1.	—
16.5	7	4 1.7	, . 113.	, . 895/26.	—
16.5	6	4.3 2	MAP, 18, . 119—120.	, . 41/27 .	—
11.2	7.3	2.3 1.3	, . 124.	, . 69170.	—
12	5.3	2.1 1.5	, . XI, ., 1915, . 35 . 5, 4.	, . 121/59 ,	—
16.2	5.3	3.4 2.5	, . 15, . 390, . 156.	, . 93/31 .	—
9-14	3.5—5.7	1.8-2 1.6-2	III . . .	, . 121/59 ,	—
10	3	1.5 1.5	, . XXIV, . 122.	, . 121/54 .	—
13.5	5	2.2 1.5	, . 94, . 7—8, . I,	, . 123/16.	—
13.5	5	2.2 1.5	12. , . 8, . II, 2.	, . 121/54 .	—

XI—XII .

17.5	5.5	—	MAP, 18, . 113.	, . 13/10 .	.
12.4	4	1.8	, . 1, 1903, 93, . 43, . . 63.	—	—
-	-	—	. XLIX, . 5, ., 1886, . 710—712.	—	—
16	5	2.8 2.8	. IX, . 1, ., 1881, . 17.	, . 125/52 .	—
16.5 15	3.5 6	3.3 2 3.5 3	, . 18.	, . 125/52 .	.
14.7	4	2 2	. I , . II, . 791, 785.	, . 121/54 .	—
14—17	3-5	2—2.3 2-2.1	III . . .	, . 23/14 ,	—
14.6	6	2.3 1.5	, . V, 5—6, ., 1897, . 1 . 17.	, . 121/54 .	—
15	5	-	, . 121/54 .	—
15	3.7	1.9 1.9	, 1930, . 296, . i ii, . II, . VI, 4.	, . 121/54 .	—

1	2	3	4	5	6	7
204			1938	5.	I	XI .
205			1890	19.	I	XI .
206			1888	23, □	I	XI .
207—208			1909	2. VI VIII.	I	XI .
209		-	1892	.	I	XI .
210		-	1889 (?)	(?).	I	XI . (?)
211			1906	1.	I	XI .
212		—	—	(?).	I	XI—XII .
213			1878	22.	I	XI .
214			1853	.	I	X—XI .
215			1851-1854	.	I	X—XI .
216					I A	XI .
217			1909	2. V, □	I	XI .
218			1912	1. I, □	I A	XI .
219			1913	65.	I	XI .
220			1928).	III	XI .
221		—	—	.	III	XI .
222				—	III	XI . (?)
223			1880	12.	III	XI . (?)
224			1900	10.	III	XI .
225				.	III	XI .
226			1892	7, □	III	XI .
227			1857	1.	III	XI .
228			1938	3. III,	III	XI .
229			1886-1887	.	III	XI .
230		»	1890	112.	III	XI .
231		»	1890	121.	III	XI .
232		»	1890	134.	III	XI .
233			1888	21.	III	XI .
234			1926	3, 1.	III	XI .
235			1892	35.	III	XI .
236			1892	12.	III	XI .
237			1912	2. 1, □	III	XI .

8	9	10	11	12	13
11. 5	3. 5	2. 6 2	WA, t. XVI, Warszawa, 1939, . 427 „. LXXVIII, 3.	- -	—
15	4. 5	2. 4 2. 2	, . 1, 1890, 32, . 39 .	17036. , . 31/39 .	.
12	3	2 2	, . XIII, . 1, „, 1899, . 147—148.	, . 31/42 .	—
14-17. 5	4. 5-5	2. 5—3. 2	1915, . XI, I. P. Paulsen. Axt und Kreuz..., . 43 .	— (?).	—
19	3. 5	3. 2 2. 5	, 277.	—
13. 5	3. 3	1. 8 1. 8	, . 22, „, 1907, . 44, . 10. , 1960, 1, . 1, 6, 9, . 72.	—	—
—	—	—	1893, . 217. , . 15, . 85 . 134.	, . 125/50 .	.
12. 5	4. 8	3 1. 3		, . 123/6 .	.
19	9	3 2. 4	III , 49, 1955, . 72, I.	,
18	9. 3	2. 6		,	—
—	—	—			—
14. 5	8	2. 8	XI, 5.	—	—
19	10	2. 8 2	, . 1, 1912, 116, . 39 .	816/2. ,
17. 7	6. 3	2. 6 2	, 1913, 123, . 23 .	818/155. ,	—
10. 2	5. 2	2. 3 1. 9	, . 2, 1929, 134, . 28—29.	700/275. ,	—
10. 5	4	2. 4 2. 4		2105/1. ,	—
11. 7	4. 7	2. 7 2. 7	, 1931, 744, . 10.	(?). ,	—
11. 4	4	2 2	, . 5, . 1, „, 1881, . 8. , . 1, 1900, 82, . 24—25, . 11 (.).	583/61. ,	—
11	5. 5	-	i , 1932, . 58, . XXI, 4. , . 1, 1892, 144, . 37 .	(?). , . 14/22 .	.
13	4	2. 5 2. 5	„, 1890, . 23—24, . 6.		.
9. 5	3. 8	2. 4 2. 4	III	, 16075. ,	—
—	—	—			—
11	4	2 2	, . 1, 1890, 32, . 51 .	, . 31/38 .	—
12. 5	5		, . 53.	, . 31/38 .	—
7	3. 5	1. 5 1. 5	, . 56.	, . 52/3.	—
15	5. 5	2. 5 2. 5	. IX, „. 1892, . 172, . III, 9.	—	—
14	5	2. 3 2. 3	, 1928, . 50, . XI, 6. . 1893, . 1893, . VII; , . 1, 1890, 207, . 157 . (.).	—	—
9. 5	3. 7	1. 8 1. 8	, . 1, 1892, 36, . 27.	, . 19/57 .	—
11	5. 5	2. 4 2. 4	, . 1, 1912, 116, . 29 .	816/4. ,

1	2	3	4	5	6	7
238		—	—	—	III	XI . (?)
239		—	—	—	III	XI . (?)
240			1890—1892		III	XI—XII .
241					III	XI . (?)
242		—	—	—	III	XI . (?)
243			1897—1898	32.	III	XI .
244			1892		III (?)	XI .
245			1906	5.	III	XI .
246			1929	3,	IV	XI .
247			1878—1886	XIV.	IV	XI .
248			1928	14.	IV	XI .
249		—	1947 (?)	3 (?)	IV	XI .
250			1960	VI,	IV	XI .
251			1875	21.	IV	XI .
252		»	1874	6.	IV	XI .
253		»	1876	4.	IV	XI .
254		»	1891	20.	IV	XI .
255		»	1891	21.	IV	XI .
256			1899	147.	IV	XI .
257		»	1901	221.	IV	XI .
258		»	1900	280.	IV	XI .
259			1900	I, 1.	IV	XI .
260			1909	II,	IV	XI .
261			1909	14	IV	XI .
262			1929	20.	IV	XI .
263			1894		IV	XI .
264		—	1880-	1.	IV	XI .
265			1880-	3.	IV	XI .
266—267		—	1880-	3.	IV	XI .
268			1880	4.	IV	XI .
269		—	1880	5.	IV	XI .
270			1840-		IV	XI . (?)
271			1903		IV	XI .
272			1906	46.	IV	XI .
273			1929	11.	IV	XI .

8	9	10	11	12	13
—	—	—	P. Paulsen. Axt und Kreuz..., . 29, . 10, .	, 6179. , -1284.	—
13.5	4.7	2.4 2.3	.	, -20996.	—
14	4.7	3 3	.	-4231.	—
12	4.5	2.3 2.3	.	, 1901, . I, 7.	—
—	—	— IV, 1901, . I, 7.	—	—
13.1	—	— XI, I, M., 1901, . 542, . V.	—	—
12.7	5.5	2.6 2.5 , 1896, . 138— 139, 703.	, , 822/50.	—
10	6	1.8 1.8 , . 94, . 12, . III, 14.	, , . 41/19 .	—
12.4	7	3.5 2.5	MAP, 18, . 100—101.	, , 700/397.	—
15.5	10		W. J. Raudonikas. Die Normannen der Wikingerzeit..., . 73 .. . 99.	, , . 283.	—
13.5	8	2.6 2.6	, 1961, 1, . I, 2.	, , . 33/51 .	—
13.5	10	3 3	.	, . 2.2/III-1	—
13.3	8.3	2 2	MAP, 20, . 59.	, . 2.2/III-1	—
13.5	8.5	2.2 2.2	, . 59.	, . 2.2/III-1	—
10	5.7	2 2	, . 78.	, . 37/24 .	—
14	9	3.8 3	, . 108.	, , 868/262.	—
15	10		MAP, 29, . 84, . XIX, 19. . XIX, 19.	, , 856/68.	—
14.5	11	2.3 2.3	MAP, 29, . 84, . XIX, 19. . XIX, 19.	, , 856/68.	—
11.6	8.5	2 2	, . 91, . XIX, 19.	, , 856/68.	—
15	9.5	3.7 3	, . 98, . XIX, 19.	, , 856/68.	—
12.2	6.7	2 2	, 1931, 740, . 104.	—	—
12	8	2 2	(.). , . 1, 1909, 31, . 29	—	—
13.8	8	2.3 2.3	(.). , . 66.	—	—
13.4	8.6	2.6 2.6	, . 1, . 1930, . 27, . 15.	—	—
-	—	— VIII, . 1 2, , 1896, . 160—161.	—	—
13	8.2	2 2	, . 198—199, 1721.	, , . 69/4.	—
10.5	6	2 2	, . 199, 1722.	, . 39/16 .	—
10—13	5—6	2 2	, . 202, 1781—1782.	, . 14/3 .	—
12	6	2.5 2.3	, . 203, 1785.	, . 14/3 .	—
13.5	8.5	2.2 2.2	, . 203, 1790.	, . 14/3 .	—
13.2	7.7	2.5 2.5 63.	, . 95/56 .	—
15.5	8.8	2.7 2.7	, . 1, 1903, 15, . 87.	—	—
13.4	9	2.5 2.5	, 1906, 30, . 33 .	—	—
13.7	8	2.5 2.5	, 1929, 177, . 11-12.	—	—

1	2	3	4	5	6	7
274	,	.	1933	3. 2, □	IV	XI .
275	,	.	1853	.	IV	XI .
276	,	»	1853	1482.	IV	XI .
277	,	.	1960	5.	IV	XI .
278—280	.	-			IV	XI . (?)
281	,	.	1895	1.	IV	XI .
282	,	—			IV	XI . (?)
283	,	.	1892	6.	IV	XI .
284	,	.	1901	.	IV	XI .
285	,	.	1890-	.	IV	XI .
286	,	.	1904	5.	IV	XI .
287	(),	.	1905	54.	IV	XI .
288	,	.	1912—1913	.	IV	XI .
289	,	.	1925	.	IV	XI—XII .
290	,	.	1952—1953	4.	IV	XI .
291	.	.	1952—1953	1. 15, □	IV	XI .
292	.	.	1952—1953	21.	IV	XI .
293	.	.	1952-1953	44.	IV	XI .
294	.	.	1952—1953	64.	IV	XI .
295	.	.	1952—1953	66, □	IV	XI .
296	.	.	1952	1. 66, □	IV	XI .
297	,	.	1901	3. 29.	IV	XI .
298	,	.	1900-	.	IV	XI .
299	,	.	1893	3.	IV	XI .
300	,	.	1939	8.	IV	XI .
301	.	.	1939	32.	IV	XI .
302	,	.	1938	1.	IV	XI .
303	,	.	1934	2.	IV	XI .
304	.	.	1934	9.	IV	XI .
305	,	—	—	—	IV	XI—XII .
306	,	.	1926	I, 1.	IV	XI .
307	.	»	1926	I, 2.	IV	XI .
308	.	.	1921	II,	IV	XI .
309	.	.	1926	1 (10). II,	IV	XI .
310	.	.	1928	7. II,	IV	XI .
				24.		

8	9	10	11	12	13
11	7	1.7	. . . 109, . . . — . . ., 1935, . . . 109—110, . . . 98, 6.	—	—
11	5	2.8 2.5	, . . 15, . . 156, . . 391.	.	—
16.1	11.3	2.7 2.7	I . . . II, . . 788 796, 783.	, . . 121/33 .	—
11.5	5.8	1.9 1.9	—
14—14.6	8.6—10	2.7 2.7	III	, . . 23/53 , 57 .	—
—	—	—	MAP, 25, . . 51, 107.	—	—
12	8	—	, 49, . . 72, 4.	.	—
14.7	8	—	, . . 1, 1892, 144, . 35	, . . 14/22 .	—
13	7.5	2.7 2.7	, 1901, 141, . . 9.	, . . 48/2.	—
15	10.5	2.8 2.8	III	, . . 43/35 .	—
13.6	8.8	—	. . . VII, . . 1, . . ., 1905, . . . 109—110.	—	—
15.3	9.5	3.7 3.3	. . . VIII, . . 1, . . ., 1906, . . . 199—200, . . 54.	812/549.	—
15.1	10.3	2.9 2.9	. . . i apxeo ii, . . III, . . 58, . . XXI, 5.	—	—
15	9.5	2.8 2.8	III	, . . 150/3.	—
14	8	3 3	, . . 2, . . ., 1957, . . 240—241, . . XIX, 8.	.	—
14	9	2.6 2.6	, . . 248, . . XIX, 8.	, . . 15/5.	—
14.5	9	2.7 2.7	, . . 253—254, . . XIX, 4.	21/11.	—
15	8	2.8 2.8	, . . 263, . . XIX, 5.	44/3.	—
13.5	9	2.4 2.4	, . . 271, . . XIX, 8.	64/5.	—
14	8.5	2.8 2.8	, . . 272, . . XIX, 7.	66/9.	—
13	9	3.3 3.3	, . . 273—274, . . XIX, 7.	66/23.	—
13.5	7.5	2.6 2.6	, . . 6, . . ., 1904, . . 13.	, . . 21/1 .	—
15	9	3 3	, . . 81, . . ., 1960, . . 26; 25.	—	—
13.5	8.5	2.6 2.6	IX I, M., 1895, . . 169, . . 52.	—	—
14.3	8.7	2.5 2.5	, 23611.	—
14.2	9.6	2.5 2.4	, . . XI, . . — . . ., 1945, . . 135.	, 24094.	—
15.3	8	3 8	Przegl d archeologiczny, t. VI, zes. 2—3, Pozna , 1939, . . 195.	, 23872.	—
14.5	9	—	Rocznik archeologiczny, t. I, Wilno, 1937, . . 24—25. . . II, . . 12.	—	—
15	9	—	, . . 24—25, . . II, 11.	—	—
13.5	8.5	3 3	—	—
15	9	2.9 2.9 ii, . . I, , 1928, . . 14, . . II, 2, . . 16.	, 637. (?)	—
16.5	12	3 3	, . . 17, . . III, 4 . . 20.	(?).	—
—	—	—	. . . 39, 41.	(?).	—
15	7.3	—	, . . 33—34, . . IX, 2 . . 37.	(?).	—
—	—	—	, . . 255.	(?).	—

1	2	3	4	5	6	7
311	.	.	1921	III,	IV	XI .
312	□	.	1890	1. 35.	IV	XI .
313	.	»	1890	40.	IV	XI .
314	.	»	1890	116.	IV	XI .
315	.	»	1890	142.	IV	XI .
316	.	»	1892	20.	IV	XI .
317	.	»	1892	21.	IV	XI .
318	.	»	1892	34.	IV	XI .
319	.	»	—	—	IV	XI . (?)
320	.	.	1892	1.	IV	XI .
321	.	.	1892	9.	IV	XI .
322	.	.	1909	III.	IV	XI .
323	□	»	1909	IV.	IV	XI .
324	□	»	1909	V,	IV	XI .
325	□	»	1909	1. VII,	IV	XI .
326	□	»	1909	1. X.	IV	XI .
327	□	»	1909	XI.	IV	XI .
328	□	»	1909	XII.	IV	XI .
329	□	»	1909	XCVII.	IV	XI .
330	□	.	1912	14.	IV (?)	XI .
331	□	.	1912	37.	IV	XI .
332	□	.	1912	95.	IV	XI .
333	□	.	1915	30.	IV	XI .
334	□	»	1915	101.	IV	XI .
335	□	.	1894	4 (116).	IV (?)	XI .
336	.	—	—	—	IV	XI .
337	.	.	1890—1892	.	IV	XI—XII .
338	.	—	—	—	IV	XI—XII . (?)
339	.	—	—	.	IV	XI—XII . (?)
340—343	.	—	—	—	IV	XI . (?)
344	.	.	1900	3.	IV	XI .
345	□	.	—	(?).	IV	XI . (?)
346—349	□	—	1892	.	IV	XI .
350	.	.	1911	5.	IV	XI .
351	.	.	—	(?).	IV	XI . (?)
352	□	.	1929	1,	V	XI .
353	.	»	1929	5, . I.	V	XI .
354	.	»	1929	2,	V	XI—XII .
				VI.		
				II.		

8	9	10	11	12	13
10	2.5 (?)	—	ii, 1.	(?).	—
14	12	2.8 2.8	. 33—34, IX, 2 . 48.	, . 31/39 .	—
13	8.3	3 3	. 41 . . 41 . — 42.	, . 31/39 , .	—
13.5	9	3 3	, . 52—52 .	, . 31/38 .	—
15	8.5	2.4 2.4	, . 57.	, . 52/3.	—
16	10	3 3	, . 1, 1892, 69, . 12 .	, . 52/3.	—
—	8	—	.	, . 52/3.	—
16	9	3 3	, . 13 . — 14.	, . 52/3.	—
15.2	8.7	3 3	III .	.	—
13	8.7	2.7 2.7	, . 19/57 .	—
11.5	9	2.5 2.2	..., .. 1899, 58.	, . 19/57 .	—
14	9.5	2.8 2.8	. 27—27 .	, . 1, 1892, 34,	—
13	7	2.5 2.5	X, 2.	—	—
15	8.5	2.9 2.9	, . X, 4.	—	—
—	—	—	, . XI, 3.	—	—
13.5	7	2.4 2.4 1915, . 10—11.	—	—
13.2	8	2.7 2.7	XII, 2.	—	—
14.7	8.8	3 3	, . XII, 1.	—	—
8.7	5.2	2 2	, . XIII, 2.	—	—
—	—	—	, . XLI, 8.	—	—
11.7	7	2.2 1.8	, . 1, 1912, 116,	—	—
13.5	6	2.5 2.5	. 39—39 .	816/234.	—
13.8	11.5	2.5 2.5	, . 39.	816/495.	—
14.7	10	2.5 2.5	, 1915, 93, . 11—11 .	819/48.	—
—	—	—	, . 22—22 .	819/242.	—
14	8.5	2.6 2.6	, 1894, 103, . 71 .	—	—
10.5	7	3 3	(?).	—
13.5	9.5	3.2 3.2	, 1915, . IX, 5.	, 32631.	—
10.6	7.5	2.2 1.8	.	-25/2589.	—
11.8—12	7.8	2.4-2.7 2.4-2.5	.	, -20690, -1204.	—
15.7	10.6	2.8 2.8	.	-4774, 19280.	—
14.2	10	2.9 2.4	, . II, . 1900, . 202.	826/5.	—
12	7	—	.	741/699.	—
14	7.3	2.8 2.8 138—139,	(?).	—
12	7	-	704—707; . 33, . 10 .	843/41.	—
13.6	6	2.5 2	. 146, i, . IX, i, 1954,	(?).	—
14.3	9	2.5 ?	. 29, . 10 .	—	—
14	8.7	2.7 ?	P. Paulsen. Axt und Kreuz...,	—	—
			. 29, . 10 .	—	—
			, . 94, . 9.	—	—
			, . 17, . V, 20.	—	—
			, . 20, . VII, 1.	—	—

1	2	3	4	5	6	7
355			1930	3,	V	XI - II
356		»	1930	17.	V	XI—XII
357		»	1919	2.	V	XII
358			1878—1886	XXV,	V	XI
359		»	1878—1886	1. XXIX,	V	XI
360		»	1878—1886	4. XLVII,	V	XI
361		»	1878—1886	2. XLVII,	V	XI
362		»	1878—1886	3. LVI,	V	XI
363	(?)	»	1878—1886	2. —	V	XI
364		»	1878—1886	LIX,	V	XI
365		»	1878—1886	1. II,	V	XI
366		—		1. (?)	V	XI (?)
367			1874	2.	V	XI
368			1928	2.	V	XI
369		»	1924	7.	V	XI
370		»	1928	2,	V	XI
371		»	1928	II. 2,	V	XI—XII
372		»	1928	IV. 2,	V	XI—XII
373		»	1928	II. 7, I.	V	XI
374			1876	25.	V	XI
375		»	1876	8.	V	XI—XII
376		»	1876	8.	V	XI
377		»	1881	30.	V	XI—XII
378		»	1879	14.	V	XI—XII
379—380			1900	3.	V	XI
381		»	1900	275.	V	XI
382		»	1900	288.	V	XI
383			1908	15.	V	XI
384			1911	18,	V	XI
385			1950-	2.	V	XI
386			1881	8 (4).	V ?	XI—XII
387			1878	1.	V	XI (?)
388		—	—	5.	V	XI
389			1929	4, I.	VI	XI
390—391			1878-1886	XXV,	VI	XI
392		»	1878—1886	2. 3. LV,	VI	XI
				3.		

8	9	10	11	12	13
13.5	8	3.5 ?	, . 40, . XIII, 8.	—	—
13	6	-	, . 45, . XV, 20.		
11	6	1.8 ?	, . 50, . XVII, 1.	—	—
9	4	2 1	MAP, 18, . 103.	, . 41/27 .	—
13.5	7.3	3.3 2	, . 104.	, . 47/27 .	—
13.3	8.5	2 1.6	MAP, 18, . 108—109.	895/55.	—
13.3	8.1	3 2	, . 109.	, . 41/28 .	—
13	6	3 1.5	, . 112.	895/41.	—
13.5	7.8	3 2.3		895/56.	—
11.7	5.5	3 2	MAP, 18, . 113.	, . 41/21 .	—
15	9	3 1.7	, . 121.	333.	—
14.5	7	3.4 2.5		895/37.	—
9.5	5	—	ESA, t. IV, . 245—246.		—
13	8	2.6 ?	, . 2, 1929, 134,		—
12.5	6.5	2.7 1.6	. 11. . . 24.	700/212.	—
13.5	7	3.5 1.8	, . 25.	700/240.	—
12	8	2.8 1.3	, . 25.	700/242.	—
13.3	9	3.2 2	, . 26.	700/246.	—
14	7.2	3.2 1.6	, . 38.	700/143.	—
14.5	8	3.2 3.2	MAP, 20, . 76.	, . 37/28 .	—
13.5	8.5	3 3	, . 78.	, . 33/5 .	—
13.8	7.3	2 1.3	, . 87.	, . VIII-2/III-1.	—
13.6	9.3	2.4 2.4	, . 94.	, . 37/54 .	—
13	8.5	2.8 2	III	, . 37/37 .	—
14.5-16.5	7.5-7.7	3-3.2 2-2.3	MAP, 29, . 59.	856/391.	—
11.5	8	2.4 1.6	, . 97.	856/59.	—
16.5	8	3.5 3.1	, . 99.	856/78.	—
15.6	8	3 ? 1909,		—
8	3	—	. 11 . . . 1931, 739, . 55—		—
10	6	2.8 2.3	56. , 65, . 25, . 5.	—	—
14	7.5	2.8 2	, . IX, . 1, . 16.	, . 125/55 .	—
11.6	5.7	1.9 1.7	,	, . 119/39 .	—
10.5	4	1.8 1.8	223. , . 203, 1791.	, . 14/3 .	—
9 (?)	5 (?)	—	, . 94, . 12—13,	—	—
14	9	3-3.6 2-2.6	IV, 2. MAP, 18, . 103.	41/18 . , . 41/25	—
12	6.8	2.2 2	, . 111.	, . 41/28 .	—

1	2	3	4	5	6	7
393			1878—1886		VI	XI . (?)
394—395			1880-		VI	XI . (?)
396			1880	47.	VI	XI .
397		»	1883		VI	XI . (?)
398		»	-		VI	XI . (?)
399			1899	369.	VI	XI .
400			1908	29.	VI	XI .
401		»	1909	73.	VI	XI .
402		—	1880-	2, 3.	VI	XI .
403			1878	30.	VI	XI .
404			1881	2 (3).	VI	XI .
405			1890	4.	VI	XI .
406			1904 (?)	8.	VI	XI .
407			1934	2, □	VII	XI .
408			1934	2, □	VII	XI .
409			1934	4, □	VII	XI .
410			1929	2, 4, .	VII	XI—XII .
411		»	1929	II. 6, .	VII	XI—XII .
412		»	1929	II. 5, .	VII	XI—XII .
413		»	1930	II. 12, .	VII	XI .
414—415			1870-	I. .	VII	XI—XII .
416			1878—1886	LIX, . 3.	VII	XI .
417		»	1878—1886		VII	XI . (?)
418			1880-		VII	XI . (?)
419			1875	6.	VII	XI—XII .
420		»	1875	19.	VII	XI—XII .
421		»	1875		VII	—
422		»	1875		VII	—
423		»	1875—1876	4.	VII	—
424		»	1875—1876		VII	—
425		»	1875—1870		VII	—
420		»	1876	36.	VII	XI .
427		»	1876	4.	VII	XI—XII .
428		»	1879	47.	VII	XI—XII .
429		»	1879	15.	VII	XI—XII .
430		»	1879	38.	VII	XI .
431		»	1879	58.	VII	XI—XII .
432		»	1881	123.	VII	XI—XII .

8	9	10	11	12	13
13	9	3.2 2.2	III	, . 41/18 .	
13. 5-14	8.5—11.2	3 2		895/39 42.	—
16	15	3 2.2	, . 32, ., 1956, . 43,	, . 150/1.	—
16	12	2.7 2.7	. 11, 4.	, . 37/45 .	—
3.4	8.5	3.5 2	III	, . 150/1.	—
15	10	3.5 2	MAP, 29, . 107.		—
13.2	12.1	3.5 2		868/133.	—
14.5	8.6	3.2 2, 1908,		—
13	8	—	. 13, 1, 1909, 31,	—	—
13.5	6.5	3 2	. 50, . 200,	, . 69/9 10 .	—
16.5	8.5	3.5 2.2	1742.	, . 42/2.	—
14	7.2	3.5 3	, . 220.	, . 125/53 .	—
12.4	8	—	, . 240, 2305.	, . 14/25 .	—
16	13.2	—	, . XV, . II, ., 1894,	, . VIII-11/II-8.	—
19.7	16.8	—	. 139.		—
11.7	8.3	2 1.5, 1913,		—
21	21	3.5 2.5	. 29, . 12.		—
16	16	—	, 1947, . 112.	1558/60.	—
18	18	3.5 (?)	, . 112.	1553/78.	—
18	19	4 (?)	, . 113.	1553/97.	—
8.7—10.9	6.7—8.9	2.2—2.4 ?	, . 94, . 12, . IV,		—
13.2	9	3.8 2.5	3.		—
17	15	3.6 3.6	, . 17, . VI, 2.		—
15.5	13	3.6 2	, . 24, . VII, II.		—
16.1	12.5	2.5 2.5	, . 32, . XI, 2.		—
15	15	3 2	ESA, t. IV, . 230.		—
17.5	14.5	3.5 2.5	MAP, 18, . 113, . XIII, 9.	, . 41/19 .	—
17.5	16	3.2 2.5	III	, . 41/21 .	—
20	18.5	3.5 3.1		895/38.	—
-	-		MAP, 20 . 60, . XIX, 20.	, . 33/47 .	—
22	16	4 2.3	, . 61.	, . 33/47 .	—
14.5	16	3.8 2	III	, . 40/2 .	—
14	10	3 1.5	, . 32, . 41, . 10,	, . 33/47 .	—
18	20		5.	, . 150/1.	—
17.5	17	3.3 2.3	, . 10, 3.	, . 33/41 .	—
15.9	14	3.4 2.3	III	, . 70/1.	—
			MAP, 20, . 76.	, . 37/28 .	—
			, . 91.	, . 37/176.	—
			MAP, 20, . 92.	, . 37/37 .	—
			III	, . 37/37 .	—
			MAP, 20, . 95, . XIX, 20.	(?).	—
			, . 95.	, . 37/55 .	—
			, . 112.	, . 31/58 .	—

1	2	3	4	5	6	7
433—438			—		VII	XI—XII
439			1882	—	VII	XI—XII
440		II.	1900	271.	VII	XI
441			1899	1, 3.	VII	XII
442			1954	II,	VII	XI
443—444			1851—1854	22.	VII	XI . (?)
445			1952—1953	64.	VII	XI
446			1947	1.	VIII	XI
447—448		—	1880-		VIII	XI . (?)
449			1928	20. II,	VIII	XI
450		—	1947	5 (?).		XI
451			1880	2, 2.		XI
452			1913		I	XII
453			-	(?).	I	XII—XIII
454			1889—1890		I	II- III
455			1890—1892		I	XII—1- XIII
456			1901		I	XII—1- XIII
457			1876		I	II- III
458		—	—	—	I	XII—XIII (?)
459			1957		I	XII—1- XIII
460—461			1931—1932	—	I	XII—XIII
462			1875	22.	IV	XII
463		»	1881	3.	IV	XII . (?)
464		»	1881	3.	IV	XI—XIII
465		»	1879	4.	IV	XII . (?)
466		»	1881		IV	XII . (?)

8	9	10	11	12	13
14.5— 18.5 27	12.5 - 18.8 23.5	3-3.7 1.8-2.5 4.5 3	III . . .	, . 41/30 .	—
16	16	3.5 (?)	MAP, 29, . 97, . XXVI, 6.	872/1.	—
12	11	2.5 (?)	, . 1, 1899, 74,	(?).	—
18	15.5	3.5 (?)	—
18- -19	16.5—18	—	, . 15, . 156, . 394; III . . .	, . 121/59 .	—
15.6	10	2.8 (?)	, . 2, . 1957, . 271, . XIX, 3.	61/1.	—
10.5	7	—	. VII. , . 1, 154, . 23	. . .	—
12—13	7-8.5	3-3.5 1.5-2.7	. . .	895/44 62.	—
12	4	—	. 91 . XVII, 2. ii, . I,	(?).	—
13.8	19.7	2.5 2.5	, 1961, 1, . 205, . 1, 2.	. . .	—
13.1	16 (?)	2.5 2.5	, . 200, 735.	, . 69/9 10

XII—XIII .

15	3.5	2.5 2.5	. . .	591/10.	—
15.3	7	2.6 2.6	Wilno i ziemia wile ska. Wilno, 1930, . 120, . 150, 37.	- . .	—
14	6.5	3 2.2	. . .	, AR-254: 25.	—
12.5	4	2.3 2.3	—
15.6	5	3 1.8	. . .	, -1203.	—
19	6	2.5 2.5	1899, . 113—114, XT AC. . 921—930.	, I-963.	—
14.5	4.5	2.2 2.2	. . .	, -	—
14.9	4	2.4 2.1	. . .	, 418.	. . .
12	3.5	2.3 2.3	1933, . 15, . II, . 2, Ca ip, . 2.	. . .	—
13.5	12	2.7 2.7	, 20, . 71.	, . 33/37 .	—
13	10.5	2.2 2.2	, . 94.	, . 37/54 .	—
13.7	9	2.8 3	MAP, 20, . 96.	, . 37/24 .	—
7.5	6	2 2	, . 111.	, . 37/60 .	—
13.5	11	2.8 2.8	III . . .	, . 40/31 .	—

1	2	3	4	5	6	7
467			1959		IV	XII—XIII
468			1893	3.	IV	II- III
469		—	—	—	IV	XII—XIII
470			1889—1890	15.	IV	XII—XIII
471		—	—		IV	XII—XIII
472			1958		IV	XII—XIII
473			1880-	4.	IV	XII
474			1890—1892		IVA	XII — 1- XIII
475			1950		IV	XII — 1- XIII
476			1930-		IVA	XII — 1- XIII
477			1958		IV	XII — 1- XIII (?)
478			1892 (?)		V	XIII . (?)
479			—	—	V	XIII . (?)
480			1876	3.	VII	XII—XIII
481		»	1876	44.	VII	II- III
482		»	1881	15.	VII	XII—XIII
483		»	1881		VII	XII—XIII
484			1903	3.	VII	XII—XIII
485		»	1880-	21.	VII	XII— III
486			1880-	IV.	VII	XII—XIII
487			1879	13.	VIII	III . (?)
488			1928		VIII	XII—XIII
489			1882	1.	VIII	XII—XIII
490			1938		VIII	XII— III
491—492			1930-		VIII	XII — 1- XIII
493—494			1957		VIII	XII — 1- XIII

8	9	10	11	12	13
13	12.2	3 3			—
13	10	3 3	, . II, ., 1894, . 50—51.	724/13.	—
12	9	3.2 3.2			—
13.5	9	3 3		, AR-249: 2.	—
14.8	8.5	2.7 2.7		, 639.	—
13.5	10	3 3			62
14	7.5	2.5 2.5	,, . 132, 833.	, . 31/33 .	—
12.5	12.5	3 2.8		, 32632.	—
12.5	10	2.8 2.8			—
12.5	11	3 2.6		267.	—
13.5	12.2	3			—
12.3	4.6	3.5 2.7		, -1443.	—
12.5	8.3	2.7 2.4			—
14.5	9.3	3 3	MAP, 20, . 71.	-1472.	—
12	7.4	2.8 2.8	III	, . 33/41 .	—
16	8	3 2		, . 31/58 .	—
17.5	12	4.2 2.5		, . 150/1.	—
14.5	9	—	. 139, . VII, . 1, ., 1905,		—
20	10.7	—	, . 141.	(?).	—
14	9	3 3		(?).	—
13.5	9	2.5 2.5	MAP, 20, . 84.	15452.	—
9.1	6.1	1.8 1.8	, . 5, . — ., 1940, . 304—305	, . 37/55 .	—
12.7	9.5	2.8 2.8	,, . 318—319, 22.	, . 35/37 .	—
13.5	9	3.2 2.5			—
12.5—14	7—9	2. 6-3 2. 6-3, 1950, . 92—93, XII, 9.	259; , 3/ 7-39.	492
12.5—13.7	6—7.5	3 3			493

(?) X—XII . ()

1	2	3	4	5	6	7

			X —	XI .		
I	,	-	1877	2.	X—XI .	ESA, t. IV, Helsinki, 1929, . 239.
II-III	,	.	1878—1886	LII LXVIII, 1.	X— . XI .	MAP, 18, ., 1895, . 110 116.
IV	,	»	1878—1886	II, . 2.	X .	, . 124.
V	,	»	1878—1886	, CLV, . 2.	X .	, . 125.
VI	,	»	1878-1886	CLX, . 1.	X .	, . 126.
VII	,	»	1878—1886	II, . 6.	. 1000 .	, . 127—128.
VIII	,	»	1878—1886	CXXIV, .	X .	, . 133—135.
IX—X	,	.	1920-	1 2.	X . (?)	. 20. . . 2, 134,
XI	,	.	1910-1911	1.	X .	1914, XV , . I, M., 414.
XII	,	.	1910—1911	1.	X .	, . 415.
XIII	,	.	1910—1911	.	X .	, . 421.
XIV	,	.	1870-	2.	X .	1864—1876 1—12, ., 1876, . 97.
XV—XVI	,	□	1843—1844	.	X—XI .	, 96.
XVII-XVIII	,	.	1898 1914	8 9.	X .	, . 15, ., 1905, . 35; . III, . II, , 1916, . 39.
XIX	,	.	1862	□	X .	. 1. — ., 1950, . 128.
XX	,	.	1876	.	X .	, . 190—191.

1	2	3	4	5	6	7
				(?) XI—XII		
XXI			1878-1886	XXXVIII, .2.	XI .	MAP, 18, . 106.
XXII		»	1878—1886	LIX, . 2.	XI .	, . 113.
XXIII		»	1878—1886	III, . 3.	XI .	, . 120—122.
XXIV			1913	2.	XI . (?)	327, . 4 . — 5, . 1, 1913,
XXV			1947	1 (12).	XI .	, . 1, 154, . 55.
XXVI			1910—1911	3.	XI .	XV , . 1, ., 1914, . 416.
XXVII— XXIX			1874—1875		XI—XII .	MAP, 20, ., 1896, . 59—60 .
XXX-XXXI			-		XI—XII
XXXII			1899	—	XI—XII (?)	, 1903, . 513.
XXXIII			1878	40.	XI .	, . 81.
XXXIV— LXXIII *			1851—1854		X—XI .	., 1893, . 221. . 17, 266/2, . 38 8, 2, . 20 ., 4, . 12 I , . II, . 758 .
LXXIV			1890	65.	XI .	32, . 44 ., . 1, 1890,
LXXV		—	1876		XI . (?)	, 1899, . 104, XI 513.
LXXVI		—			XI—XII
LXXVII		—	—	—	(?)	., 1895, . 41. .
LXXVIII			1858		XI—XII .	, . 13.
LXXIX			1903		XI . (?)	, 1903, 5, . 331—332.

*

XI—XIII

1	2				6	7
		3	4	5		
1			1906	18.	I	XI
2			—	—	I	XI (?)
3			1949—1951		I	IX—X
4		A.	1952		II	XII—XIII
5			1955		II	XII
6—7			1882		II	XII—XIII
8-9			1890-		II	XII—1- III
10-35			1930-		II	XII—1- III
36—39			1948-1953		II	XII—1- XIII
40—48			1957—1959		II	XII—1- XIII
49-50		»	1957—1959		II	XII—1- III
51			1903	4.	III	XII—XIII
52			1958—1959		III	XIII
53			1932—1939		III	XII—1- III
54			1938	VIII.	III	1- XIII
55		—	—	—	III (?)	XII—XIII
56			1953		III	XII—1- III
57			1960		III	XII—1- XIII
58					III	XII—XIII (?)
59—60			1936—1937		IV	XII—XIII
61—62		—	—	(?).	IV	XII—XIII
63			1912		IV	XII— III
64			1894		IV (?)	XII—XIII
65		—	1875		IV	XII— III
66			1890		IV	XII— III
67		—	—		IV	XII—XIII

()

8	9	10	11	12	13
4.6	4.7	1.6	1, 1906, 30,	—	
5	6.5	2	48 . . . 32.		
13.3	4.8	1.7			
3.6	5.3	2.5	65, ., 1959, . 135,		
—	—	—	. 7, 3. . 137.		
3.3	5	1.9	. 6—7. ., 1882, 66.		
3—3.6	4.5—5.5	1.4—2.7	1892, . 101; . XXXVI, . 1898, . 18, 769.		
3	5	1.6	. 12—14. , 1950, . 95, . XII,	. 151/1; . -22/117;	17
2.5-4.2	3.7—5.5	1.3—2.4	i i ' . III, i , 1952, . 177, . 1, 5: .		
2.1—2.8	3.3—6.8	1.3			
5.2	6.2	2.2	. VII. . 1, ., 1905, . 140 . 84.		
5.2	6.5	2.8	. 92, ., 1960, . 111 . 56.		
5.8	4.5	1	. 41, ., 1954, . 54, . 22, 13.		
5.5	7.8	2.5			
—	—	—	1951, . 34 . 23. 1906 ., 1907, . 40.	(?).	
5.1	6.5	2.1			
4.4	6.5	1.8			
8.5	7.5	2.5	. Lehoczky. Adatok hazánk archaeológiájhoz, t. 1, Munkács, 1892, . 46.	—	
5. 1—6	7.3—8.5	2—2.8	M. 1, . — ., 1958, . 82.	(?).	
6-5.5	6-6.5	2—2.3 IV, ., 1901, . II, 101—102. . 54, ., 1914, . 104, . 11.	3264 -525. -68445,	
5	7.3	2.3		—	
4		 1896, . 105, 639.		
—	—	—	. XI . . 1899, . 148, 322.	—	
6	8.5	3		. -68449, -1209.	
3.5	5.5	1.8	. 146, . XII, I. III, ., 1901, XI ., . 49, 26.	. -68452, 621.	

1	2	3	4	5	6	7
68		—	1910		IV	XII—XIII
69		—	1890-		IV	XII — 1- . XIII
70		—	—		IV (?)	XII—XIII (?)
71—74			1930-		IV	XII — 1- . XIII
75			1949		IV	XII — 1- . XIII
76-77			1958		IV	XII — 1- . XIII
78			1895	2.	IV	XIII— XIV
79		—	-	—	IV	XII—XIII (?)
80			1945		IV	XII-XIII (?)
81		—	1959	(?)	IV	XII—XIII (?)
82		—	—	—	IV	XII-XIII
83—84		—	—		IV	XII—XIII (?)
85			1951—1955		V	1- XIII
86		—	1890-		V	XII — 1- . XIII
87			1901		V	XII — 1- . XIII
88					V	XII—XIII
89			1930-		V	XII — 1- . XIII
90			1957		V	XII - 1- . XIII
91			1951		V	XI . (?)
92			1929—1930		VI	XII—XIV
93					VI	XIII
94			1953		VI	XIII . (?)

XI—XIII

1	9	3	4	5
I			1951—1955	
II			1936	
III		—	—	
IV		—	—	—
V		—	1892	

8	9	10	11	12	13
5	7.5	2	.	, III-126.	,
2.8	4	2.2
—	—	—	. 18, 767.	.	.
5	7.3	2.2	, 159, 639.	—	.
5.2	7.3	2.2	. 95, XI, 7 8.	.	1 .
5—5.8	6.1—7.5	2—2.4	. 9, I, XLI, 1951, 51,	.	.
5	7	2	.	.	.
10.2	9	2.2	1896, VIII, 171.	, 41/35 .	.
3.4	5.7	1.6	.	, -30407, -1920.	.
5.2	7.3	2.2	.	, III-3021.	.
3	5.5	2	.	.	.
3.2—3.5	5.5-6.3	1.8—2.1	.	.	.
6.1	6	1.7	, 65, 135, 7, I.	—	.
—	6	—	—	.
4	4.7	2.3	. 18, 766.	(?).	.
5.2	5.8	1.8	.	.	.
4	5	2.4	. V, 104, 621	.	.
3.7	5	2.5	.	, -22/118.	.
2.9	4.3	2	, 75, 1959, 188	.	.
16.5	10.5	3	191, 32, 4, 190.	.	.
9.3	8.3	2.5	, 1961, 89, 7.	(?).	.
10.5	8.5	3	. IV, 70, V, 1902,	, 921.	.

()

6	7	8
III — XIV .	, 65, 1959, 135, 7, I.	.
XI—XII .	, 1936, 280, 4.	43 .
XII—XIII .	.	(?).
XII—XIII . (?)	1950, 95.	.
XII—XIII . (?)	. 171, 8, XI, 1899,	.
	. 1895, 80.	.

1	2	3	4	5
VI VII—VIII		—	1890-	

X—XIII

1	2	3	4	5	6	7
1—7			1951-1960		I	2- X—XII
8			1956		I	XII
9			1945—1951		I	XII
10		—	1930		I	XIII— XIV
11			1956		I	XII— III
12			1929—1935		I	XII—XIII
13			1957		I	XII - 1- XIII
14—15			1953		I	XI—XIII
16		—	—		I	II- III
17			1956		I	XII—XIII
18—19			1957—1960		I	XII - 1- XIII
20—34			1950—1951		I	IX—XI
35			1951		I	X— XI
36—38			1951—1960		II	XI—XII
39			1936		II (?)	XI—XII
40			1940, 1948—1949		II	XI - 1- III
41			1936—1937		II	XII— III
42		—	1893		II	XII—XIII
43		—	—		II	XII— III
44		—	—		II	(?) XII— III
45		—	1894		II	(?) XII—XIII
46—47			1890-		II	XII - 1- III

6	7	8
XII—XIII . (?) XII—XIII .	i , 1898, . 18, 768. ii , 7, i , 1959, . 33.	—

()

8	9	10	11	12	13
4.3—11	4—5.5	3.2—5.5 65, . . 1959, . 133, 137—138, . 7 9; 1961 , 65, . 138. . I, , 1957, . 45 . 244. , 41, 1954, . 88, 19. , 65, . 138. , 1950, . XXXI, 18. 7/435.		
—	—	—			
5.8	4	—			
—	4	—			
5	4	—			
5	4	—			
4.8—8	4.2—5	4.2—4 , 2, , 1959, . II, 42 44 122. , . II, 43.		
5	3.9	—			
8.2	4.8	—			
6.2—11.5	3.6—7	3.6-7			
4.7—12.5	3.9-6.2	 , 75, 1959, . 71, . 21 . 188, . 32, 2 7 . 190.		
5.7	4.5	— , . 50, . . 1953, . 108, . 45, 4	(?).	
4.3—6.5	2.3—4	— , 65, . . 1959, . 138 . 7, 6 9 . 135; 1961 IV, , 1937, . 328.		
—	—	—			
—	—	—			
5.1	3.8	— , 1958, . 82. (. , . 5, 398, . 148).		(?).
7.1	3.6	—	 , 2358, -1211.	
5.4	3.8	— IV, , 1901, . II, 107.	(?).	
9.1	5	— , 1896, . IX, 670.		
5.5	4	— , 1898, . 18, 771 772.		(47).

1	2	3	4	5	6	7
48—51		—	—		II	XII—XIII
52			1959		II	XII—1- XIII
53		—	-		II	XII—XIII
54-57			1950—1951		II	XI (?)
58—59			1951		II	X— XI
60			1949		II	XII
61—62			1902		II	XII—XIII
63		—	—		II	XII—XIII (?)
64		—	—	(?)	II	XII— III (?)
65		—	—		II	XII— III (?)
66—68		—	1890-		II	XII—1- III
69—73		—	—		II	XII— III (?)
74		—	—		II	XII—XIII
75—77			1929-1935		II	XII—1- XIII
78—79			1958, 1959		II	XII—1- III
80			—		II	XII— III
81			1930-		II	XII—XIII
82		—	1890-		III	XII— III
83		—	1893	(?)	III	XII—XIII
84		—	—		III	XII—XIII
85			—		III	XII— III
86		—	—		III	XII— III
87—89			—		III	XII— III
90			—		III	XII—XIII
91-95			—		III	XII—XIII
96			1957		III	XII—1- XIII
97—98			1929—1935		III	XII—1- XIII
99			—		III	XII— III

8	9	10	11	12	13
4. 8—6	2. 2-3. 2	—	.	.	—
5. 3	3. 6	—	.	.	.
7. 2	3. 9	—	. 1; 3. , . 52, ., 1953, . 12,	, III-3045.	.
4. 5 - 6. 5	3—5. 7	—	. 75, 1959, . 188	.	.
4	3. 5—3. 6	—	. 32, 3, 5, 6 8 . 190. . 50, . 108, . 45, 4.	(?).	58 — 59 —
6. 3	3. 6	—	.	.	.
5. 5 - 6. 5	3. 5—4	—	1961, . 302, . 137, 3 4.	2493/175.	.
5. 8	3. 6	—	(.) .	.	.
6	4	—	(. A, . 5, 398, . 138).	.	.
5. 5—6	3. 5-4	—	. XIX, . VI, . 1907, . 327.	.	.
		3	. IV, . 202; . V, . 1902, . XI, 688;	.	.
5. 3—6	3. 4 - 3. 6	—	. (.) ,	.	.
6. 2	4	—	8950, 13275, 13280, 22079, 2354. . 8951.	.	.
5. 1—6. 2	3. 2-4	—	.	, 22/113—115.	.
5. 5—6. 3	3—4	—	.	.	.
5. 5	3. 4	3	1960, . XIX, 2.	.	.
	—	—	i — i , 1944, . 182 . 70,	, 346.	.
—	—	—	24. , . 164, 824.	.	.
6. 7	3. 9	2. 9	(. , . 5, 398, . 139).	, -1415.	.
7	3. 9	3	8955.	, -30840.	.
7	4	3	.	, 22080.	.
6. 2—7. 2	3. 6—4. 3	2. 8—3. 1	. II, 105, 106. IV, . 1901,	, -1415.	.
6. 7	3. 8	2. 9	.	, 22078.	.
5. 8—6. 6	3. 4—3. 6	2. 5 - 2. 8	8954, 13285, 13286 (.) , 13341.	, -1415;	.
5	3. 7	2. 3	.	.	.
3. 7-4	2. 2—2. 3	2. 7—1. 7	.	, -22/III 116.	.
6. 1	3. 1	2. 4	MW, t. V, Warszawa, 1960, . XIX, 4.	.	.

1	2	3	4	5	6	7
100			1931 — 1932		III	XII—XIII
101		—	—	—	III	XII—XIII
102—103			1932—1931 1951— 1955		III	2- XI—XII
104		—	1946 (?)		III	XII . (?)
105-106		—	—	(?)	IIIA	. XII .
107		—	—		III	XII—XIII
108		—	—		III	XII— III
109—111			1959 1962		III	XII — 1- III
112		—	1890-		IV	XII—XIII (?)
113		—	—		IV	XII—XIII (?)
114		—	—		IV	XII—XIII (?)
115-117			1890-		IV	II - 1- III
118					V	XII— III
119		—	—		V	XII— III
120			1958		VI	III . (?)
121		II.			VI	III . (?)
122	(?)	—		—	VI	III . (?)

XI—XIII

I			1876	11.
II		—	—	—
III				
IV		—	—	—
V				

8	9	10	11	12	13
—	—	—	ip, 1933, . 16 . II, 5.		
6.1	3.7	2.8	. I, I, 2. . 52. ., 1953, . 12,	, III-966.	
5-6.5	3.3—4	1.8	. 11, 1949, . 149 . 22,	102	
			. 150; . 65, 1959,		
			. 138 . 7, 5 . 135.		—
5.5	3.5				
6.5—6.8	4.4—4.5	2.5 (?) V, . IV, 203,	2501.	
			204; (.),		
			13342. (.),	, -1415.	
6.5	3.8		22077.		
4.8	3.3	1.9 IV, . II, 108;		
			(.), 13279.		
5.6—7	2.5—4.1	1.5-2.3		
5	3.3	3		, . 69/4 .	
4.8	3.1	3			
			(.) .	(?).	
			13340. (.) .		
4.4	2.6	2.6 V, . IV, 201;	, 2350, 2351. □	116.
		 V, 622.		115,
8	7.3	7.3 V, 622.	, 3-1496.	
8	5	5		, 2-2076.	
7.7	4.5	4.5			
7.2	4.4	4.4		, . 19/56 .	
		 □		
			. XXV, 6. ., . 1899,		
6.6	4	4		, -1625. □	

(HE BECTE)

XII—XIII . (?)	MAP, 20, ., 1896, . 91.				
XI—XIII . (?)	. 70, 988. XI ., 1899,			—	
XII—XIII . (?)	(.), 8953.			—	
XII—XIII . (?)	, 8949.			—	
XII—XIII .				, 748.	

	CLXVII.		379;	399.		325.
	LXXIX.		62.			29;
	271.				VIII.	183,
	H.	XV—XVI.				243;
	250.		99;	4—6,		20.
	08.	38, 39, 64,	65, 99.			
	209, 244, 346—349.		344, LIV;			382;
	307, XCVIII—;	353, 411.				44, 275.
	223.		17, 18, 75, 239.			
CLXXIX;	[1, 2		354;	II.		48.
	64.			L.		342.
	197.		386, 404.			[441—446, 468,
	58.	370, 371,	XIII—XIV,	III—	469, 539—556;	459, 477,
	87.	XXXII;	15, 74—84,		493, 494;	40—50, 57, 76,
	288.	103—118, 164—166,	172—175,		77, 90;	13, 52, 78, 79,
	355, 356.	185—188, 199—201, 215, 443,	444, XXXIV—LXXIII.		109—111.	
	372.	464, 521—523,	LXXXVIII;			397.
	239.	41;	18, 19, 96.			477.
178, 215;	37, 118,		332, 427;			524,
102, 163, 198, 276.	40—43, 66, 100—		449.			316, 317.
	XXVII—XXIX.		283.			CL, CLXXXII.
	XI.		81.			376.
	358, 390,		270.		30, IV, V;	339, CXLVI;
391.	36, 59,		427;		219, 237, 322—334.	207, 208, 217—
60.	340.					42.
	238.					224.
	CXXXVIII.					65.
	414—417;	40.	430, 482—483;			70;
	52.		362;		108,	91—95.
	24—25;		485;			158, 418—419;
	253, 375.					53;
	61, 62;					43.
107.	513—515, XLV.					79.
	50—58, LI					250—251, 375;
	7, 71, I;					409.
	81.					250.
	452.					420.
	12—14, 69, 70.					428;
	63.					232.
	24;					273.
33, 147.	280.					170, 191—200;
	210;					29, 57, 92—93, 131;
	2.					35, 58—59.
CLXIX—CLXX;	421, 422,					90.
	80, 99.					67, 68.
	264.					17.
						387.
						331, CXXXVII;
						227.

	252;	299.	51, 91—95, 122,		309.
	272;	1.		3;	392.
		83—84.	181, 365, XXIII.	144,	454, 455;
352, 385;		316—318, 351,	XXXIII.	213, 403,	240, 241, 295,
401.		383, 384, 400,		244;	254—255, 484,
				21;	396, 397;
	253;	302.		221, 249, 450.	485;
	407, 453.			277.	51.
	V;	XIV.		284.	203.
	I.			[], 188,	CXXXIX.
	80, 172;	367,	341, 435, 436, 457—462, 491—510,		78.
368.			557, 558;		294;
	30, 79;	148-	474, 478;	240, 337, 455,	XXVII—XXIX.
150, 178.			VI;	8, 9, 69, 86,	230—231, 314.
		101.	46, 47, 66—68, 115—	VI;	47, 426, 479, 480;
			117, V.		472;
					9.
					XXXIII.
					174—176, 219,
					35.
					XI, XII;
					49.
					357.
					XLIX.
					5.
					CXLIV;
					205,
					312, 313.
					69, 155—157, 391,
					12, 13.
					63, 119—121, 179;
					278—280.
					406;
					441.
					()-
					263.
					303, 304.
					344, LXXVIII.
					67.
					286.
					359, XXI.
					278.
					335.
					320, 321, 353, 363—
					366, 399—402, 452, XCVI;
					5, 6, 31, 32;
					34, 162,
					385;
					4, 85, I;
					1—7, 36—38, 102, 103.
					245.
					LVII;
					XXV.
					39, 40.
					462.
					366, 393—395, 417, 418,
					447, 448.
					405.
					248.
					292.
					LVIII.
					III, LIX, LX;
					XII, XXVI.
					351.
					119.
					33, 83.
					306—308.
					86.
					425, CLXXVI;
					453.
					CLXXIII—
					CLXXV.
					LXXVII.
					XXXII.
					249.
					283;
					374,
					426.

319.	VI—X;	34—36, 84—95, 220,	82.
468.	169.	7; 37, 61,	290.
257.		432, 433, 486—	11.
373, 374.		339, 456;	287; 377,
55, 438.			463.
156—161.			
246.	355, 434.		193.
17.			233.
338; IV.		XLI.	222.
243.		162, 163; 24.	
	285.	CXXXIII;	
		LXXIV.	442.
		121.	387—390;
39, 40, 221—222, 329;		467.	290—296, 445.
11, 45, 184.		305;	LVI; 446.
516, CLXXXVI.	379, 380.	225, 288.	64; III.
104.		408.	377.
195, 196.		(), 218;	235.
286.		4; 95.	XCIV—
CXXXV—CXXXVI.		429.	XCIV.
64—66, 122—		69—73, 63, 113.	159, 160.
144, 180—182, 217, 223—228,		356;	394; 430,
XV—XVII;		120.	431, 487.
16, 17, 46, 189.		68, 150, 456,	22, 23; 262.
[], 343;		216, 282; 226.	266—269, 388.
27, 28; VII—VIII;		LI;	
14, 15.		194.	410—413. [],
22, 76;		293.	171, [201—212, 234—237,
168, V.		183.	LI—LIII;
		403.	3, 91; 20—34, 54—57.
488.		259.	305, 471.
		460, 461;	263; 369.
		34; 202.	407—
		71—73.	CLXXX.
			204, 228.
			49, 50, 161, 184,
			XXIII— I—II;
			22, 51, 53, 125;
			11. 69—73.
			406.
			251.
			CLXVI.
			51—53, 164, 165,
			185—187; 54, 88, 89, 126,
			127.
			254, 333; 300, 301.
			83.
			12, 267, 268.
			384; 1, 138, 362, 363,
			392.
			381.
			(), 69—73.
			25—28, 32, 214, 271—275, II; 153—155.
			XCIV;
			XXX—XXXI.
			396.
			465; LV; 135—
			136, 220.
			46.
			318.

—	—	MAK	—
—	—	MAP	—
—	—		—
—	—		—
—	—		—
—	—		—
—	—		—
—	—		—
—	—		—
—	—	OAK	—
—	—		—
—	—		—
—	—		—
—	—		—
—	—		—
—	—		—
—	—	CA	—
—	—		—
—	—		—
—	—		—
—	—		—
—	—	ESA	— Acta Archaeologica.
—	—	FM	— Eurasia Septentrionalis Antiqua.
—	—	MW	— Finskt Museum.
—	—	SMYA	— Materiały wczesno redniowieczne.
—	—		— Suomen Muinaismuistoyhdistyksen Ai-
—	—		kakauskirja.
—	—	WA	— Wiadomo ci Archeologiczne.
—	—	ZWK	— Zeitschrift für historische Waffen und
—	—		Kostümkunde.
—	—		
—	—		

LES ARMES DE LA RUSSIE MÉDIÉVALE

SECOND VOLUME

LES LANCES, LES JAVELINS, LES HÂCHES D'ARMES, LES MASSUES, LES FLÉAUX D'ARMES

RESUME

Le présent volume est la suite de l'ouvrage précédent du même auteur, consacré aux épées et aux sabres du IXe—XIIIe siècle (voir «Les armes de la Russie médiévale», vol. 1). Les moyens du combat corps à corps, tel est le sujet des deux livres. Celui-ci offre un tableau des matériaux archéologiques du IXe—XIIIe siècle, arrangés systématiquement et datés. Il décrit l'apparition, le développement, l'extension et l'utilisation au combat des lances, des hâches d'armes, des massues et des fléaux d'armes. Il y s'agit également des javelins et des massues en bois (doubina). Ce volume contient aussi des schémas typologiques et des tables. A la fin de cette étude se trouve un catalogue détaillé des objets.

Chapitre 1

LES LANCES (751 EX.) ET LES JAVELINS (47 EX.)

La lance était une arme des plus employées au combat corps à corps. Son importance a surtout accru dans la période où la cavalerie devient la force principale des troupes féodales. Les guerriers et les armuriers de Kiev du Xe siècle ont utilisé les meilleures formes de la lance, apparues en Europe occidentale (type I) et en Orient (type V) en combinaison avec des échantillons slaves (type III). Si au Xe siècle il existait trois formes principales de la lance (types I, III, NIA, IIIB et V), au XIe—XIIIe siècle c'est la pique qui devient prédominante. Cette dernière s'est révélée en guise de lance de cavalerie. Au XIe—XIIe siècle on voit apparaître en Russie

l'épieu massif, ayant la forme de feuille de laurier. Cette époque est aussi caractérisée par rétrécissement de la lance, qui avait la forme de triangle allongé, traditionnelle pour le moyen âge (types IIIB et IVA). Quant aux javelins de jet (soulitsa), leurs formes imitaient certaines des pointes de lance et l'emploi de ces javelins cédaient sensiblement à celui de la lance.

Chapitre 2

HÂCHES D'ARMES (573 EX.)

D'après leurs formes et dimensions les haches d'armes se divisent en deux groupes: a) les petites haches spéciales se distinguant par leur construction et petite dimension (types I—III); b) les haches de «petites formes» (dimensions courtes: la longueur de la lame — 9—15 cm, sa largeur — 10—12 cm, le diamètre de la tête de hache — 2—3 cm, le poids — jusqu'à 450 g). Elles servaient d'instruments universels, aussi bons pour la vie en marche qu'au combat (types IV—VIII). On dirait qu'elles étaient des copies en miniature des haches ordinaires. Le perfectionnement de la hache était caractérisé non par l'invention des formes nouvelles pour la lame, mais par la création d'une tête de hache simple et solide et par une certaine modification des proportions de la partie tranchante. Toute la variété des formes des haches se forme au Xe siècle au plus tard. Vers le XIIe siècle elles deviennent de plus en plus unifiées, ce qui s'exprime dans la prédominance des types I et IVA. Au Xe siècle la hache était l'arme la plus importante des troupes d'infanterie.

Chapitres 3 et 4

LES MASSUES (102 EX.) ET LES FLÉAUX D'ARMES (127 EX.)

Les massues ont apparû en Russie au XIe siècle, empruntées au Sud-Est. Elles ont atteint leur plus large extension au XIIe—XIIIe siècle où l'on commence à fabriquer des pommeaux en bronze ayant des formes complexes et parfaites (types III—IV). La comparaison des moulages de bronze des massues a démontré que leur fabrication était centrée en premier lieu à Kiev et à d'autres villes du Sud de la Russie. Leur extension dans le pays et à l'étranger faisait naître parfois des imitations locales. Le développement de l'armement défensif a suscité au XIIIe siècle l'apparition des massues aux arêtes et des massues à bec (types IIA et IV). Les massues étaient utilisées au combat corps à corps pour étourdir l'ennemi. A côté de la massue la noblesse et les simples guerriers utilisaient également en tant qu'arme de choc les fléaux d'arme. Leurs petits poids en os ou en métal sont remarquables en Russie depuis le Xe siècle. C'est Kiev qui était un grand centre de fabrication des fléaux d'arme au XIIe—XIIIe siècle. L'origine et l'extension des fléaux d'arme indique leur rapport au combat de cavalerie. Dans la plupart des cas les fléaux d'arme russes se distinguent par leur originalité locale et dans le nombre de trouvailles européennes, ils se classent parmi les plus anciens.

«La conclusion» dresse le bilan au développement des armes du combat corps à corps en fonction de la tactique du combat, de la formation des armes et du changement de la situation politique et militaire. L'issue de la bataille dépendait de l'arme employée au combat corps à corps, c'est pourquoi on attribuait à sa fabrication une importance de premier ordre. L'arsenal de la technique militaire s'est formé en Russie au IXe—Xe siècle en même temps avec la formation de l'Etat féodal et de son armée. Jusqu'à l'invasion des Mongols les espèces essentielles de l'arme ont suivi un développement graduel. Quand même la puissance de l'arme allait toujours croissant ce qui amenait bien souvent à la modification non de toute la construction mais de ses détails. L'armement de la Russie médiévale allait de pied avec son époque et durant trois siècles il a suivi une voie complexe, pleine de recherches et de découvertes techniques. Cet armement a été créé dans une situation extrêmement tendue, causée par les guerres à deux fronts: contre les nomades d'Orient et contre certains voisins de l'Europe occidentale. La technique militaire russe du Xe—XIIIe siècle s'enrichissait constamment de réalisations des Orientaux et des Occidentaux. D'autre part, l'étude des moyens de combat russes a une valeur européenne mesurée par la grande contribution de la Russie au développement de la culture d'armurerie au moyen âge.



I. (42); * 2 (18).

*

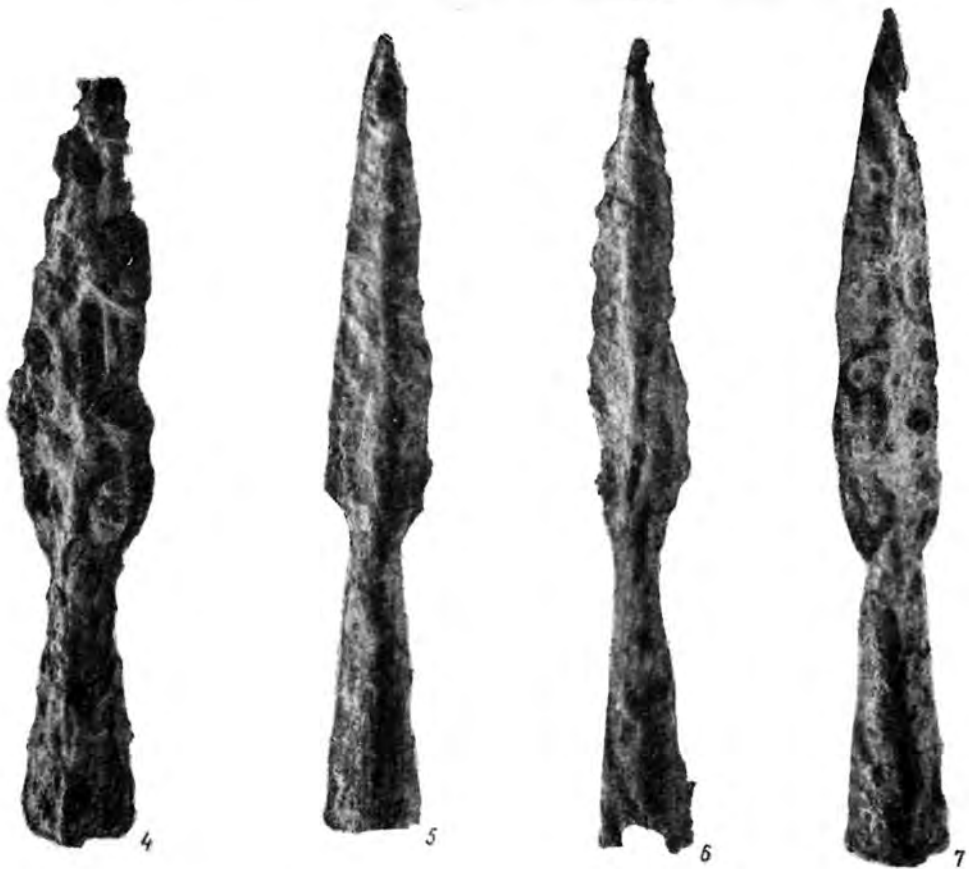

II.

1 — (33); 2 — (239); 3 — (15); 4 — (? 285); 5, 6 — (298, 299); 7 — (450).

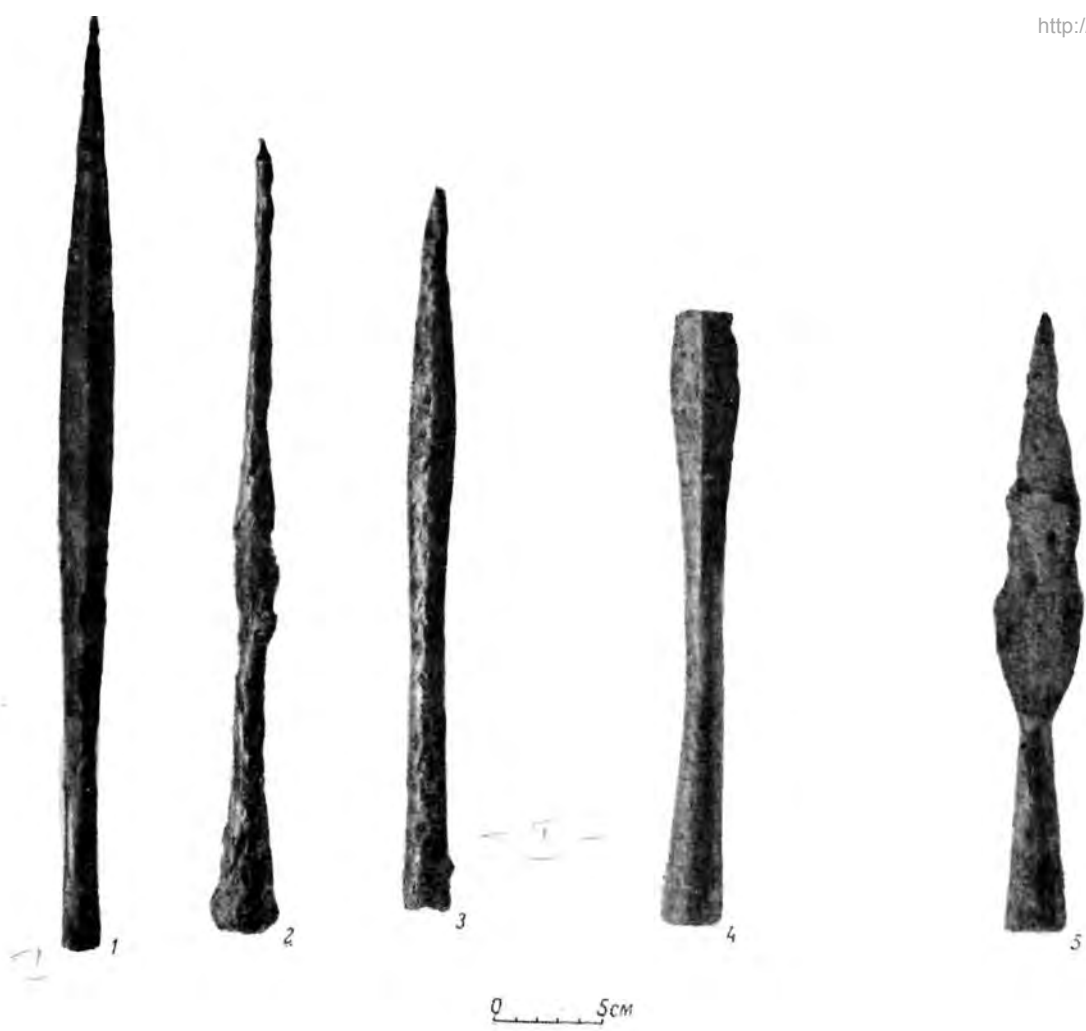

. III.

1 — (22); 2 — (279); 3 — (242); 5 — (15); 9 — (347); 6, 7 — (393); (302, 303); 8 — (40); 4 —

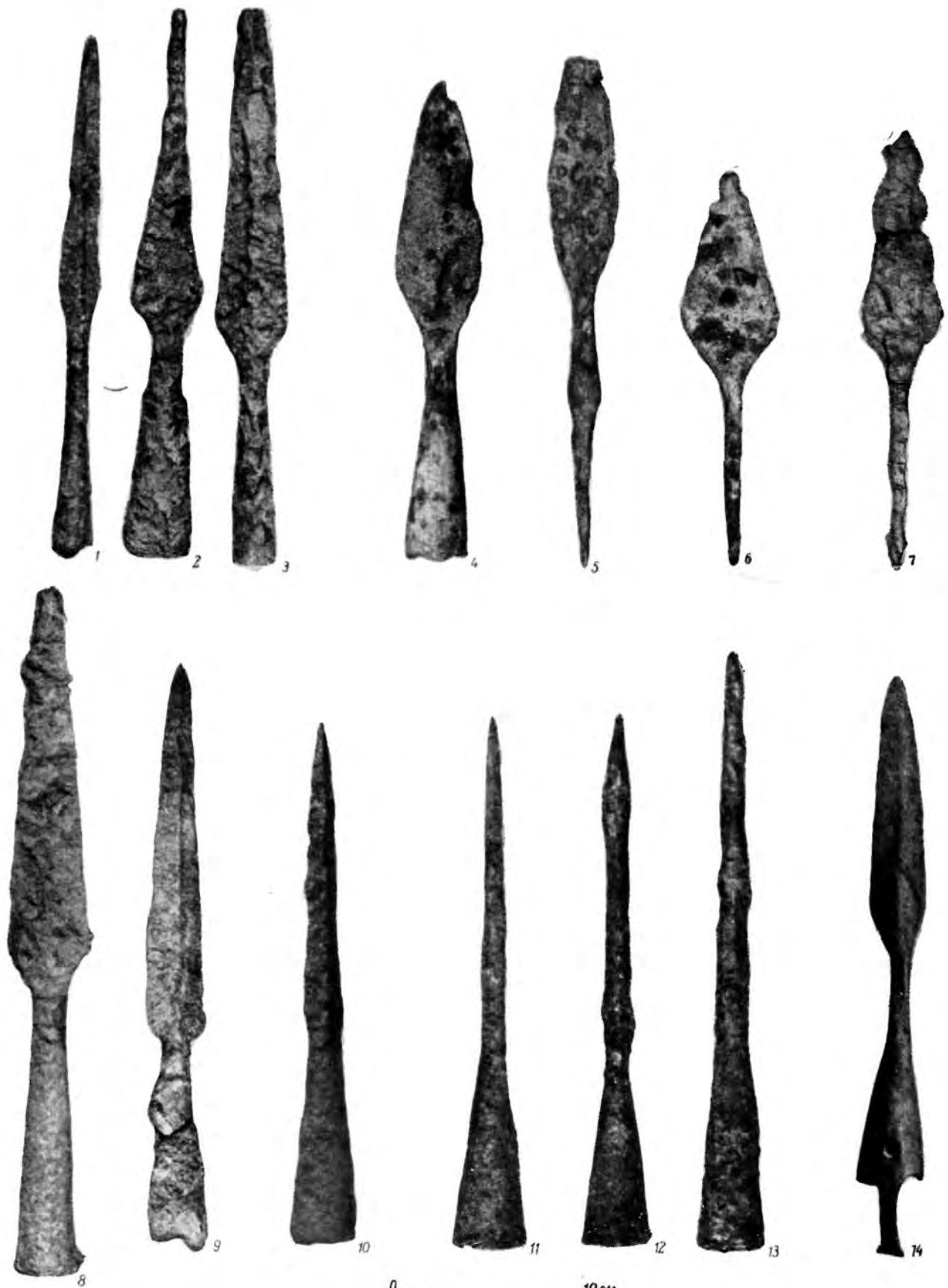

IV. (6, 7) X—XII .
 1 — (289); 2 — (7); 3 — (272); 4 — (73); 5 — (105); 6 — (215); 7 — (186); 8 — (16); 9 — (330); 10 — (277); 11 — (525—527); 12 — (465); 13 — (105); 14 — (105).



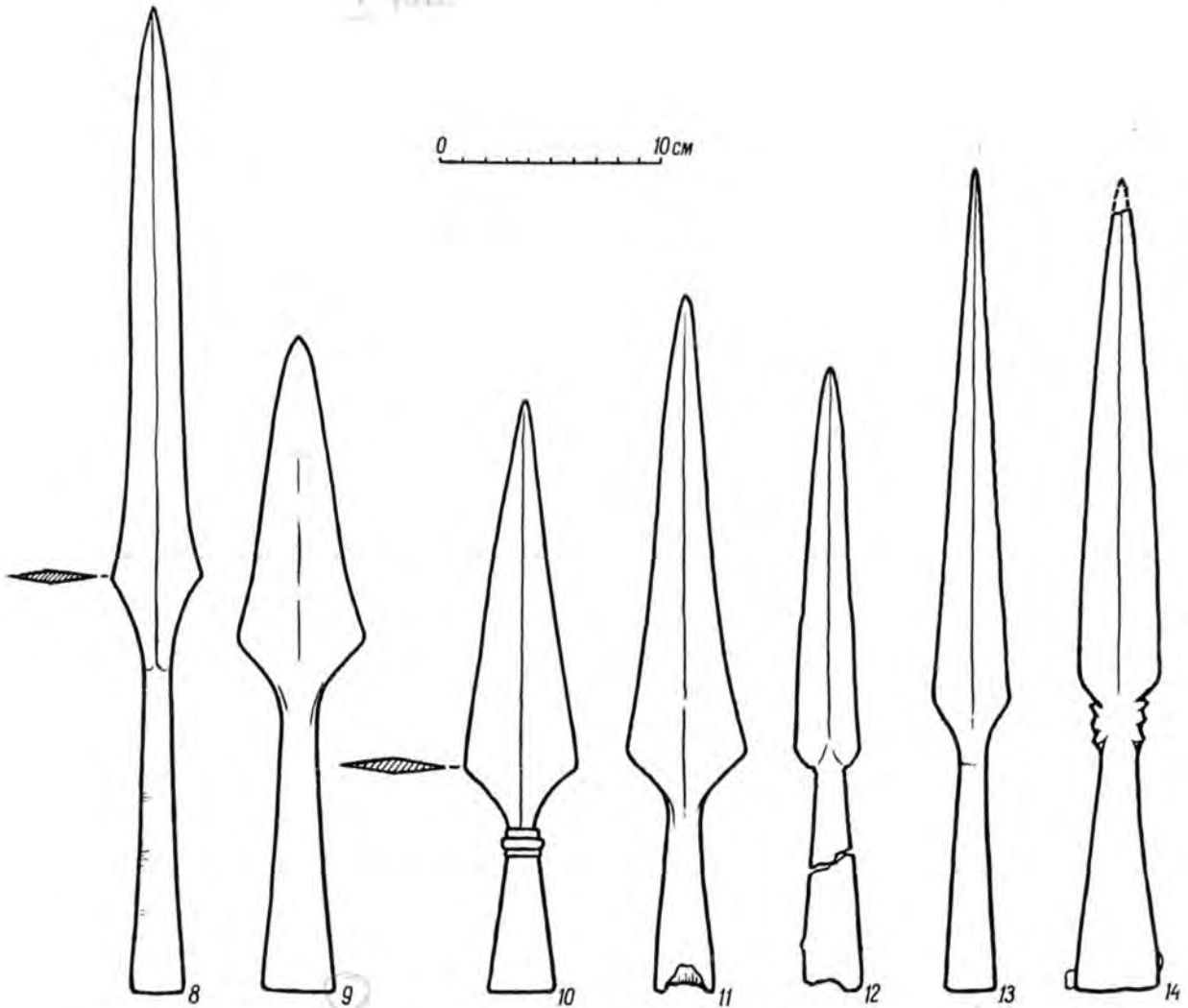
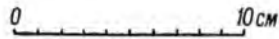
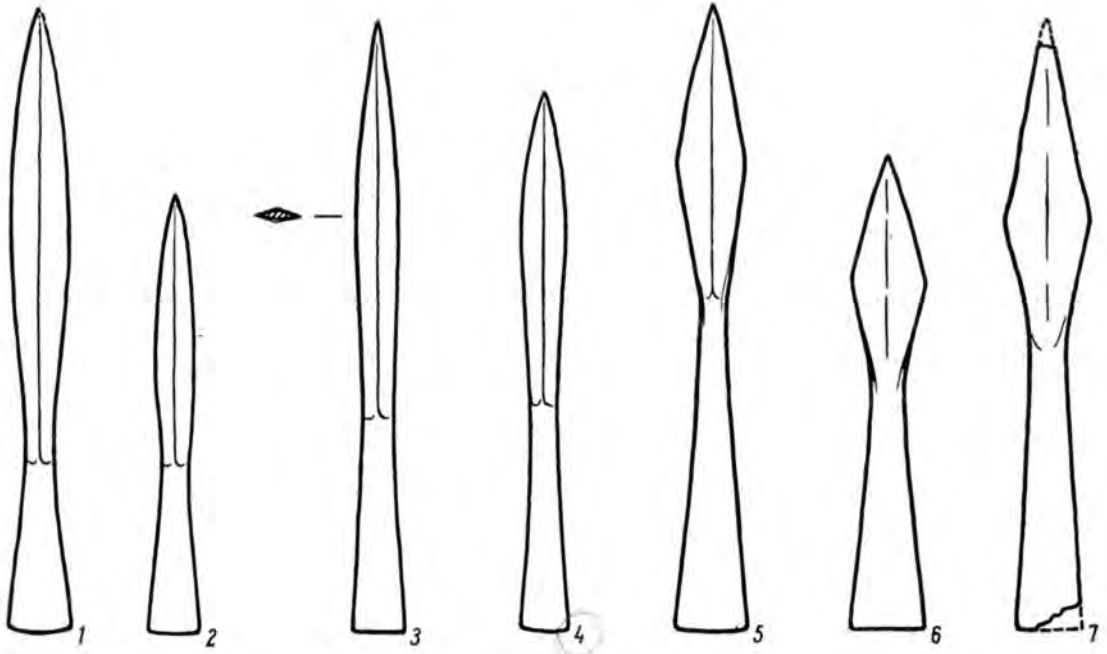

VII.

1, 2 — (19, 20); 3 — (10); 4 — (43); 5 — (59); 6 — (60); 7 — (63);
 8 — (80); 9 — (152); 10 — (311); 11 — (79); 12 — (83); 13 — (277); 14 — (440).

I — (291); 6 — (151); 2 — (400); 7 — (129); 3 — (267); 8 — (97); 4 — (98); 9 — (92); 5 — (289);
10 — (396); 11 — (410); 12 — (433); 13 — (446).

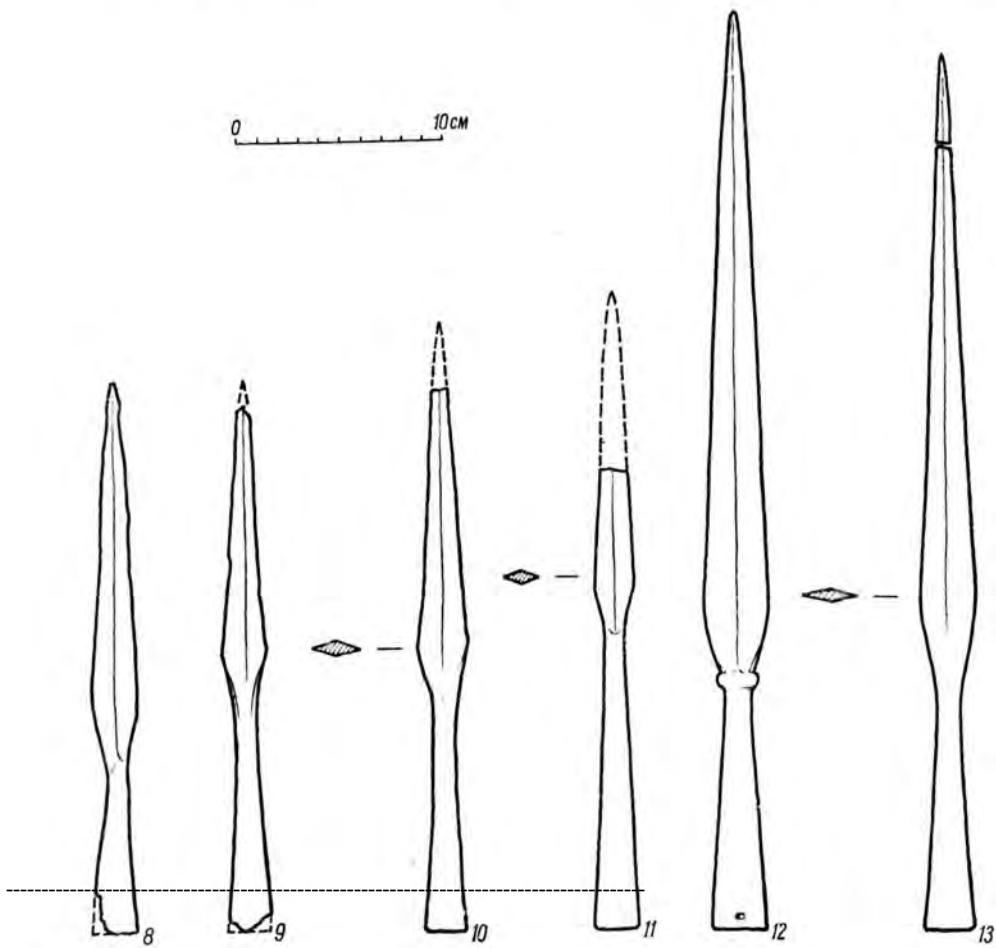
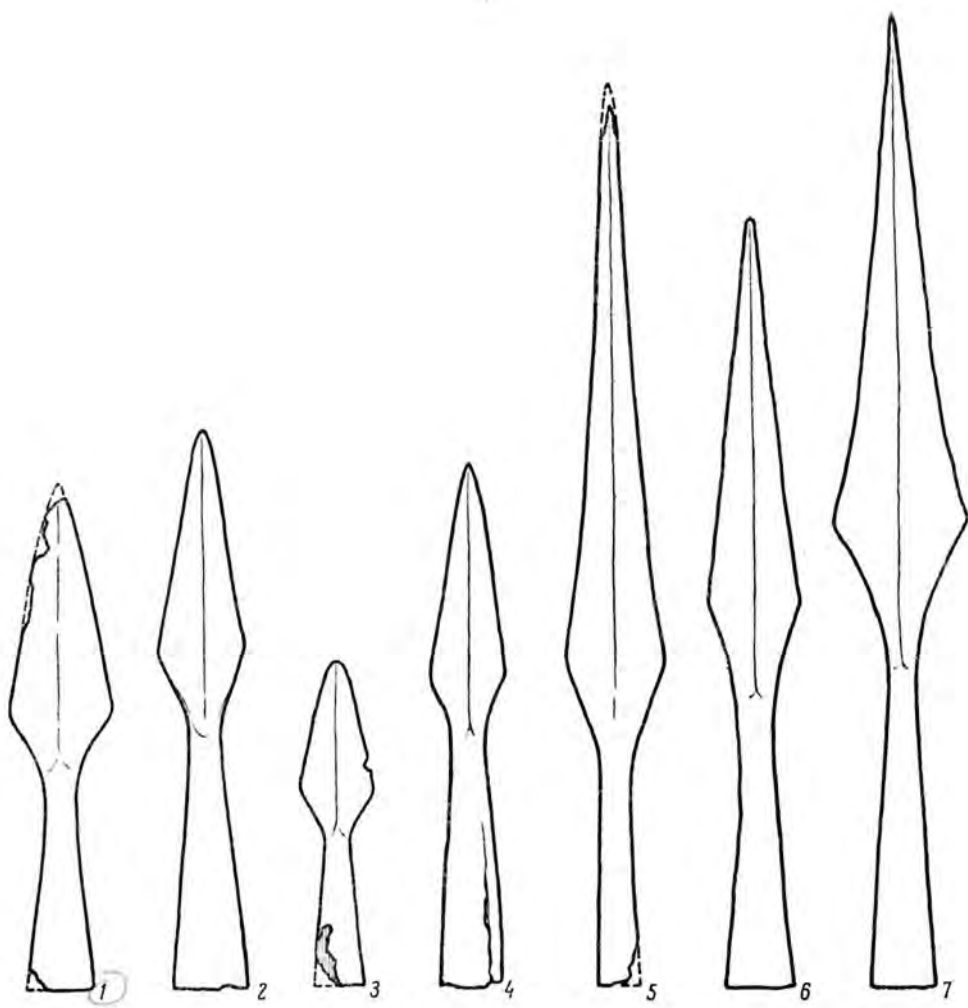

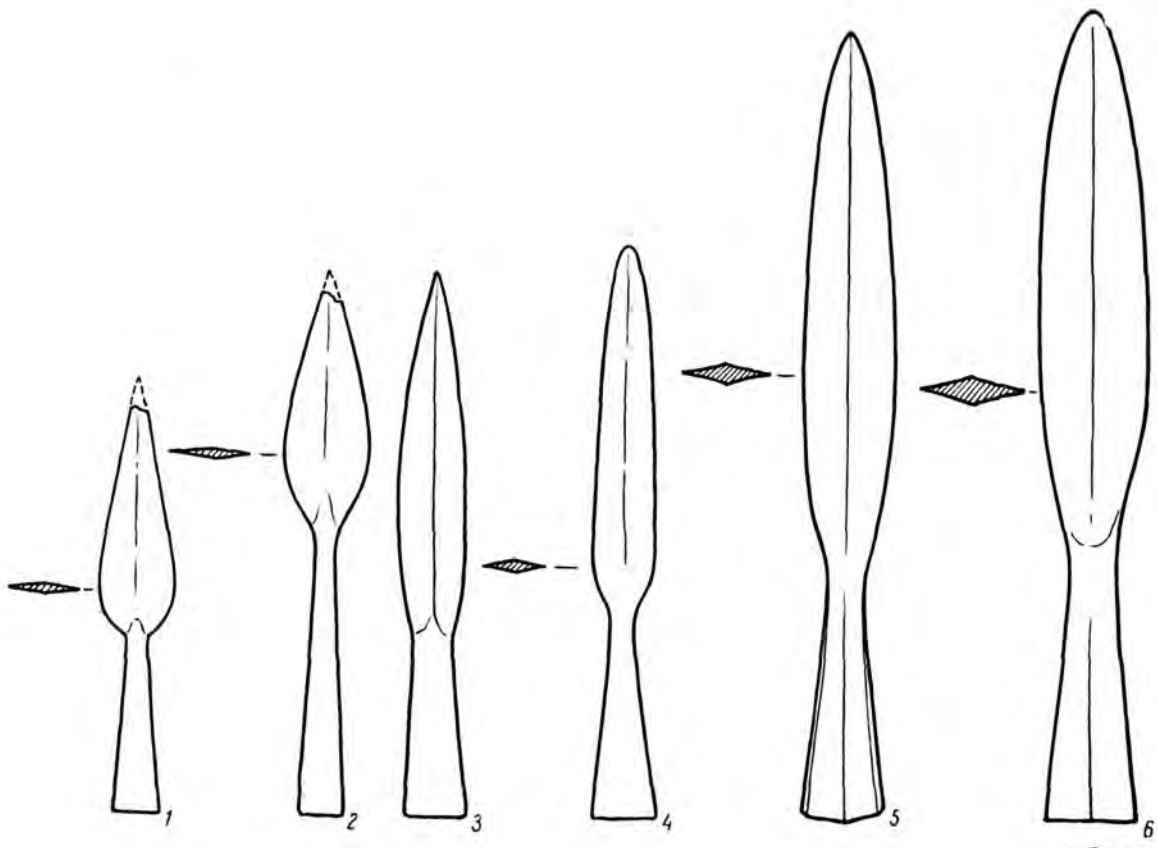

0 ————— 10cm

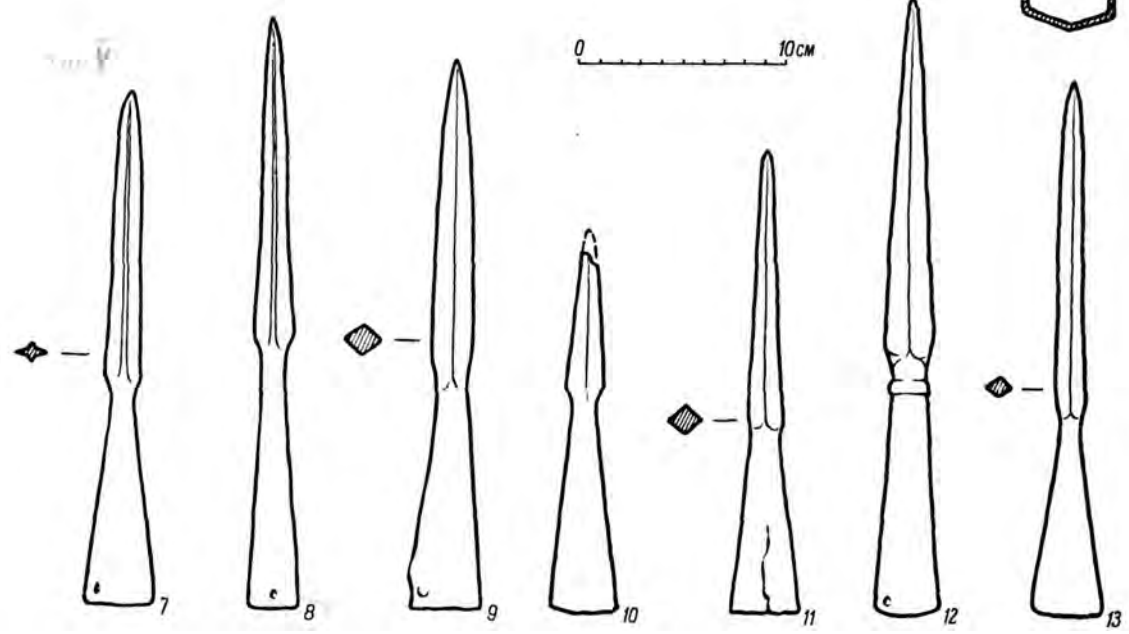

. IX.

1 — (349); 2 — (350); 3 — (450); 4 — (463); 5 — (452); 7 — (358); 11 — (455); 7 — (185); 8 — (366); 12 — (195); 9 — (369); 13 — (181); 10 — (530).

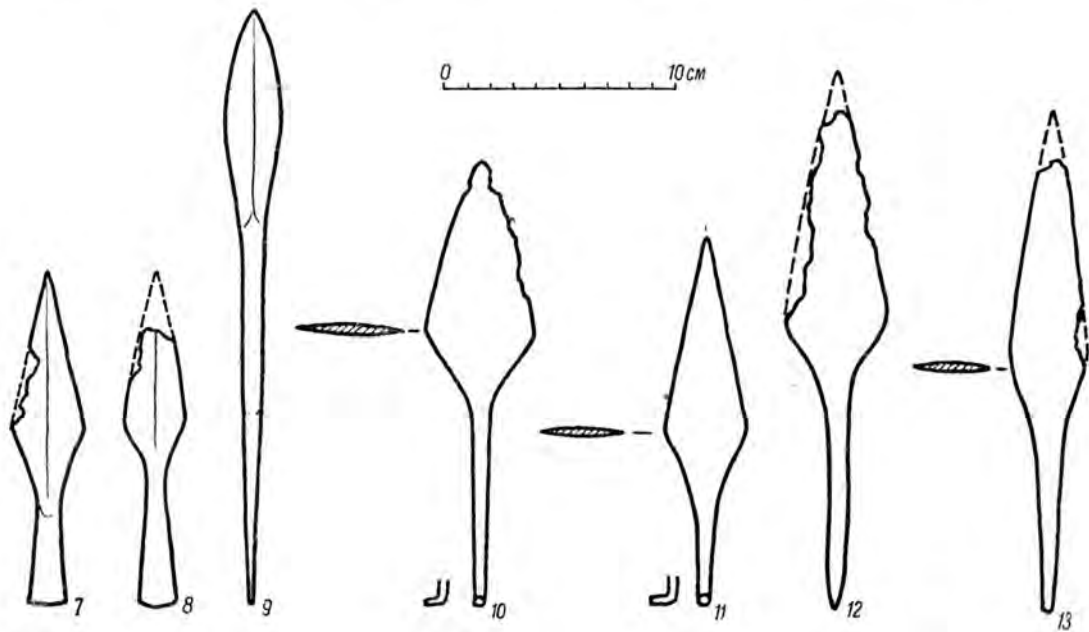
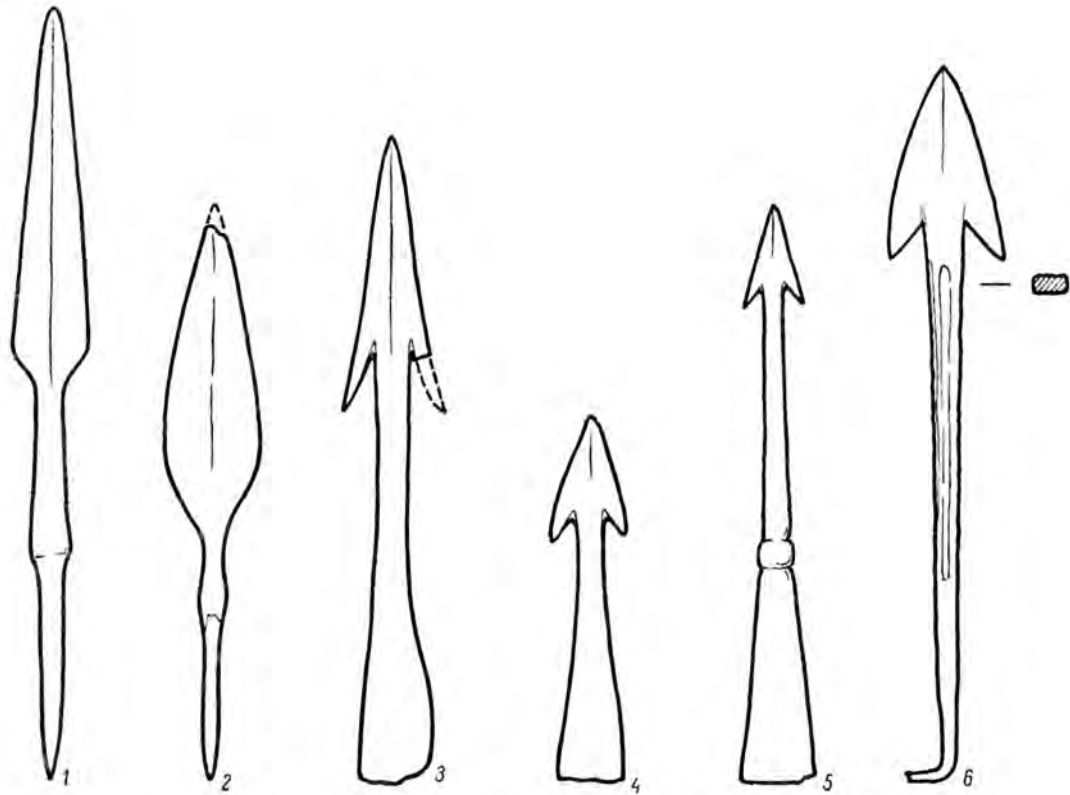

X. (1-6) (7-13) X-XIII
 1 — (213); 2 — (381); 3 — (219); 4 — (386); 5, 6 — (557, 558); 7 — (27); 8 — (5); 9 — (8); 10 — (3); 11 — (7); 12 — (16); 13 — (33).

XI—XV.

X—XIII

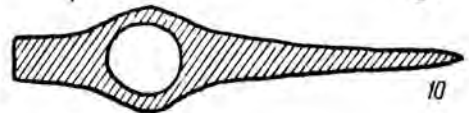
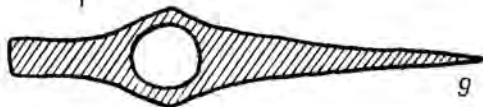
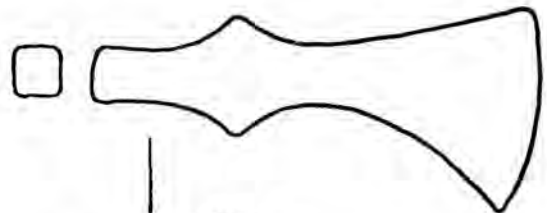
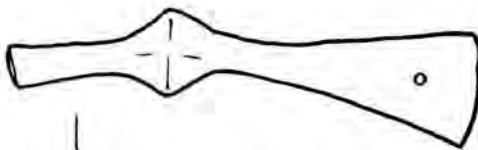
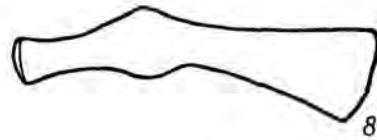
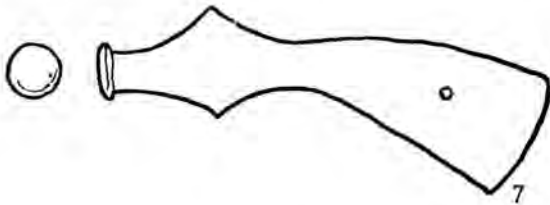
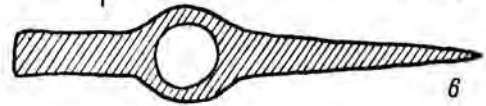
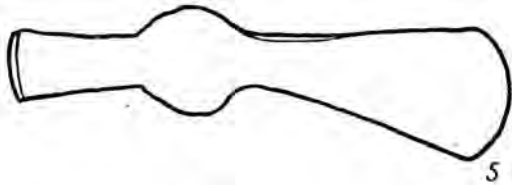
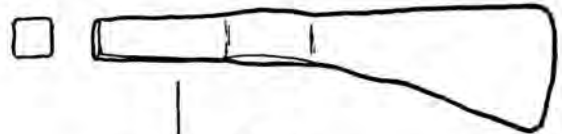
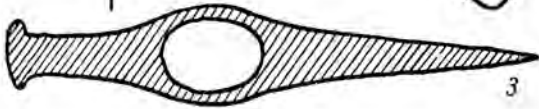
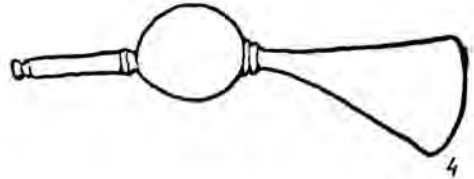
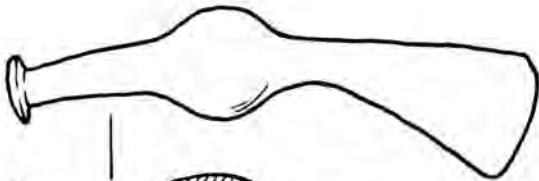
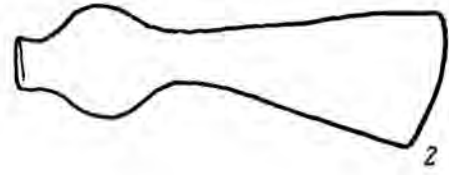
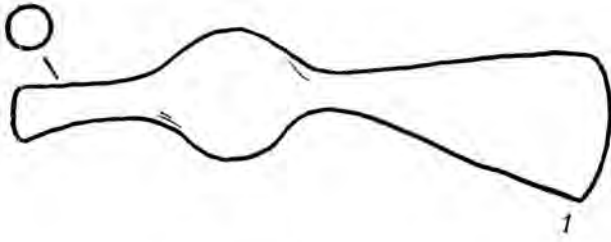

XI.

1 - (4); 2 - (198); 7 -

(7); 3 - (205); 8 -

(5); 4 - (206); 9 -

(19); 5 - (459); 10 -

(20); 6 - (453).

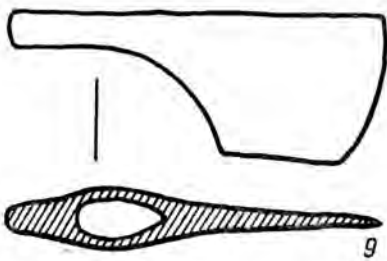
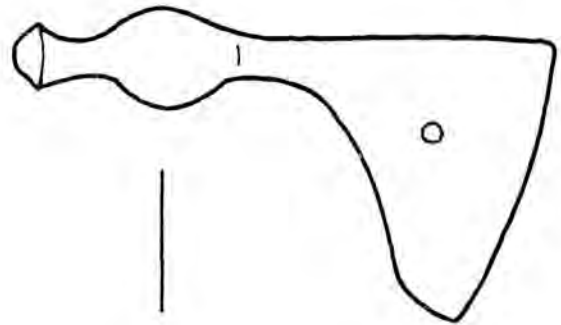
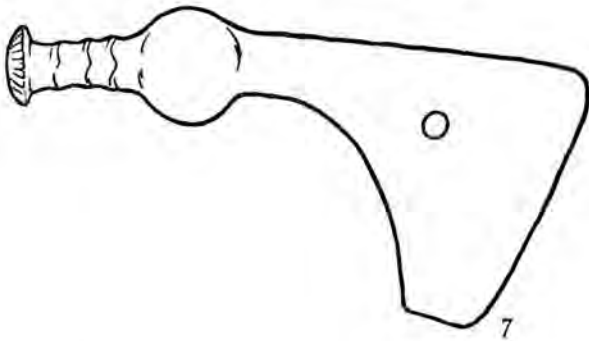
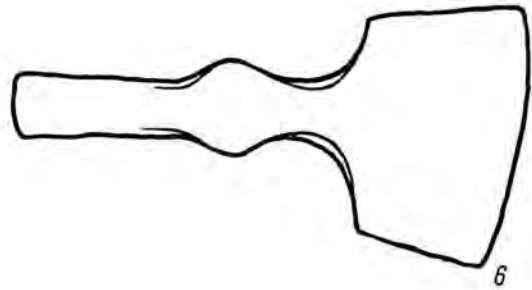
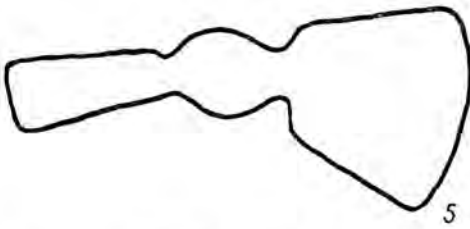
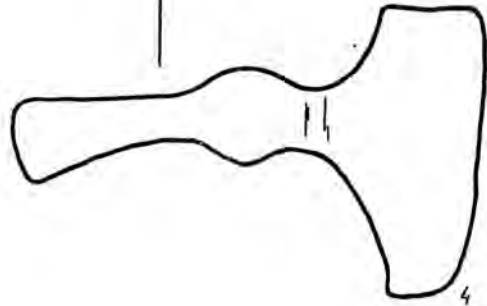
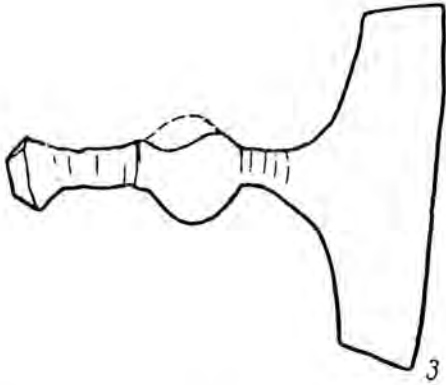
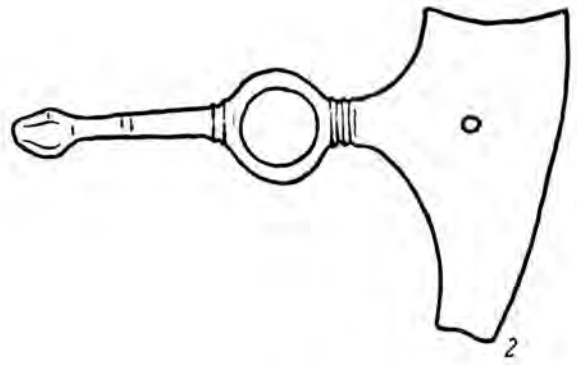
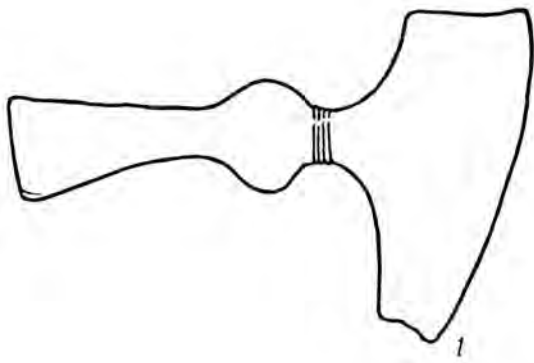

0 10 cm

XII.

1 — (33); 2 — (44); 3 — (35); 4 — (51); 6 — (32); 7 — (214); 8 — (213).

(16); 9 — (43);

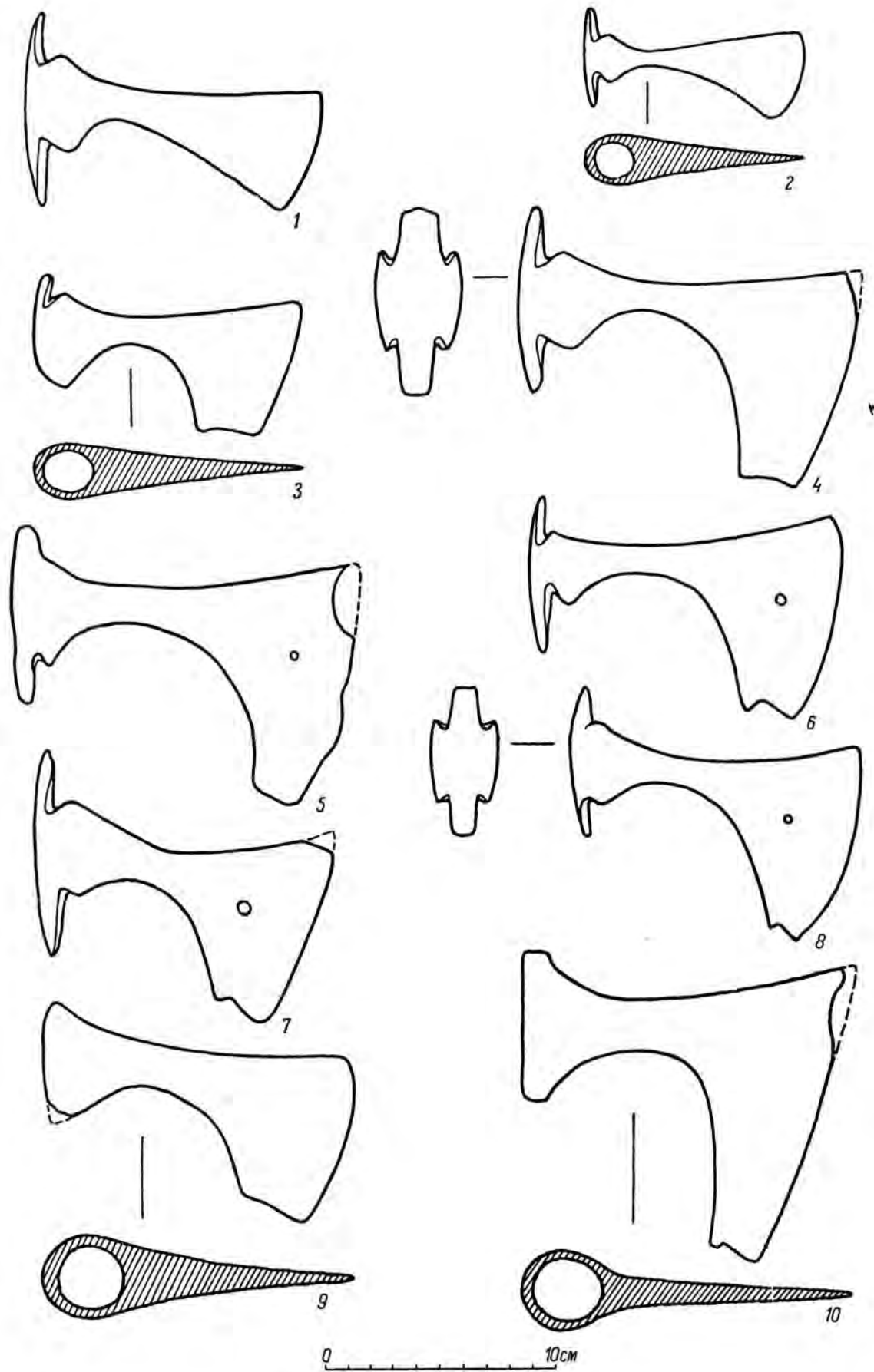

XIII.

1 — (64); 2 — (252); 3 — (313); 4 — (236); 5 — (99); 6 — (285); 7 — (313); 8 — (236); 9 — (320); 10 — (473); 11 — (122); 12 — (474).

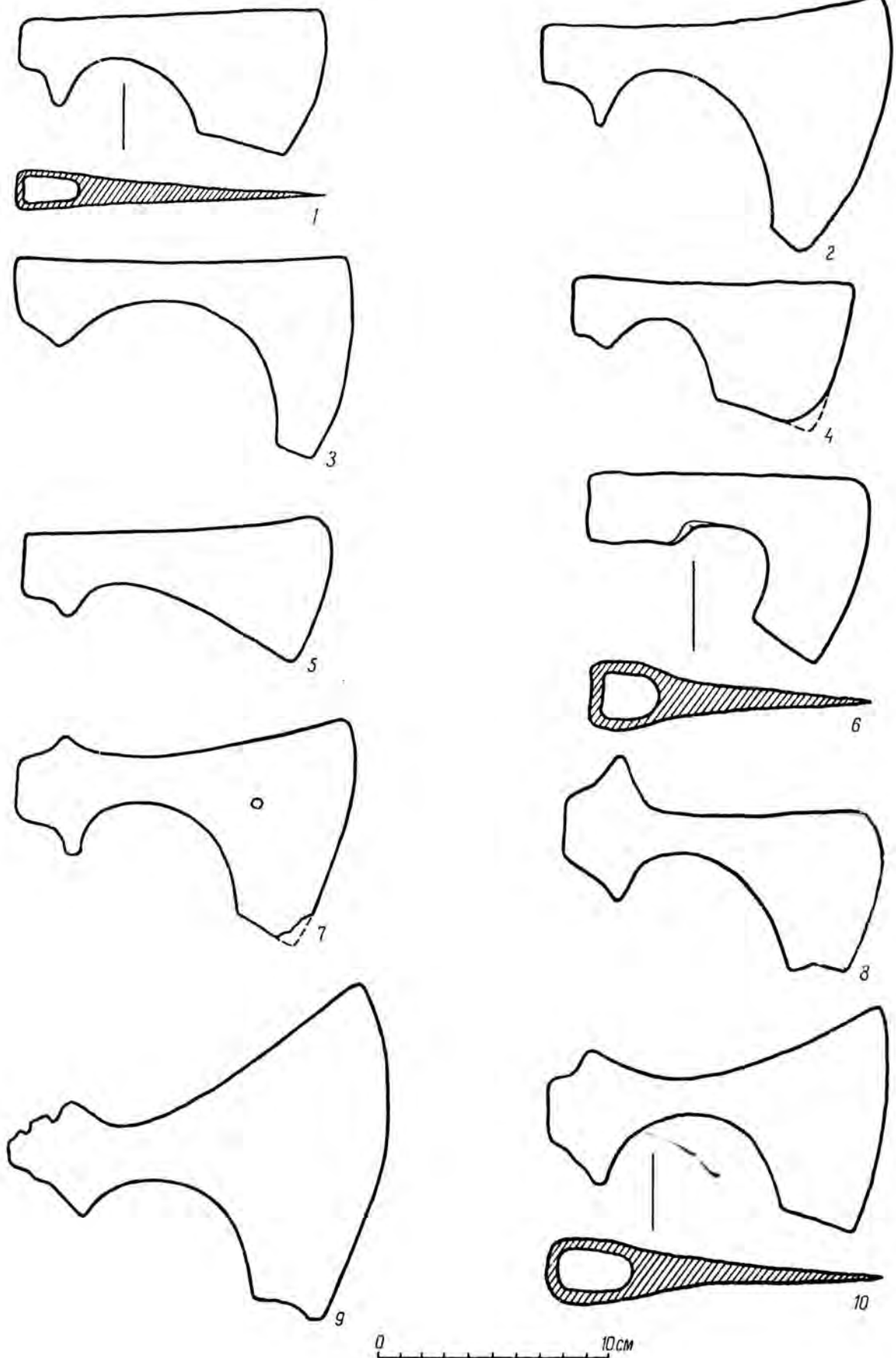

XIV.

1 — (137); 2 — (150); 3 — (374); 4 — (387); 5 — (190); 6 — (479); 7 — (390); 8 — (170); 9 — (387); 10 — (396); 10 — (190); 6 — (399).

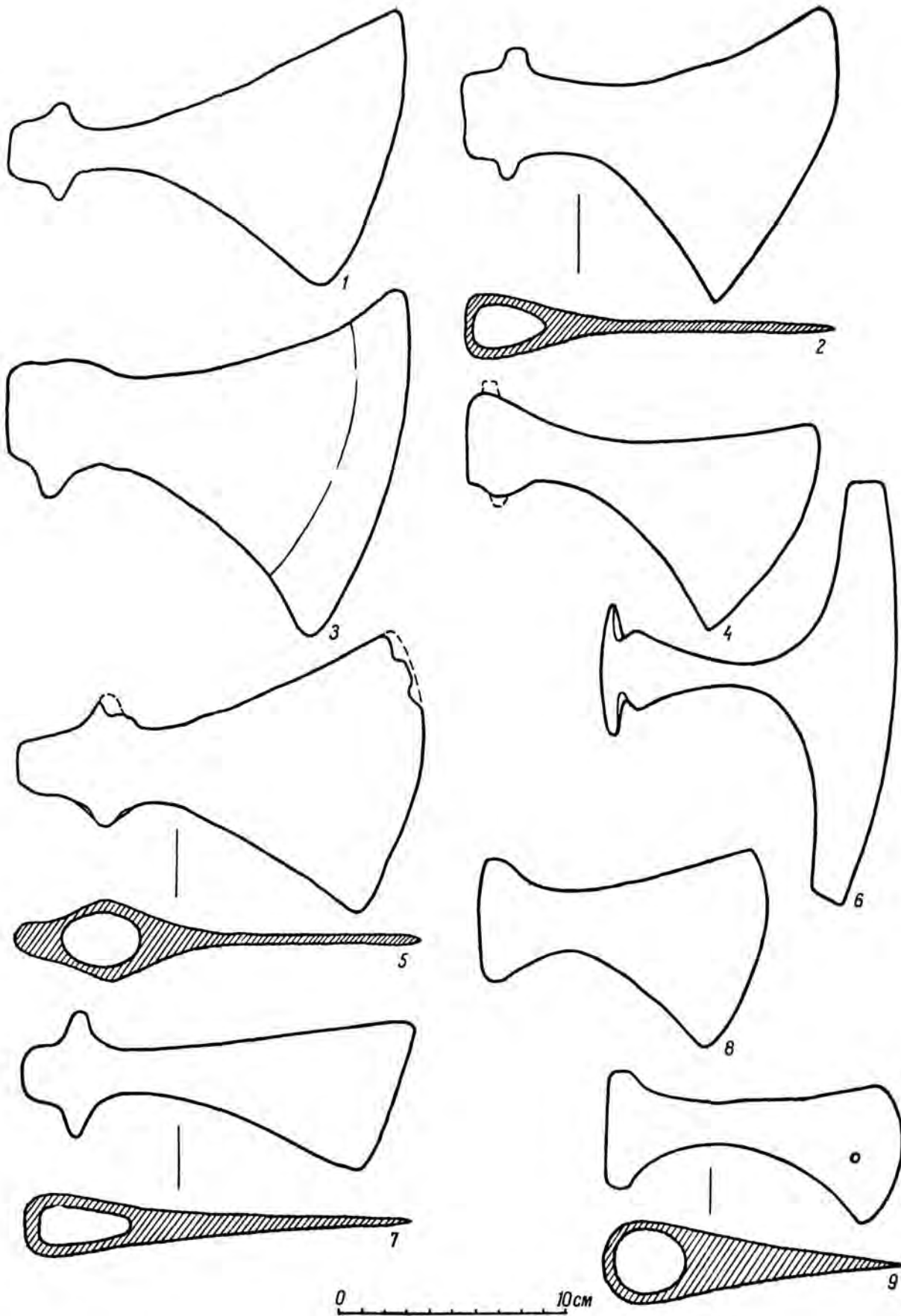

. XV.

1 — (179); 2 — (432); 3 — (422); 4 — (455); 5 — (483);
 6 — (450); 7 — (180); 8 — (489); 9 — (494).

I — 1890 1874—1875 27, 32653; 2 —
 1878—1886 150/1; 3 —
 1949 32653; 2 — 150/1; 4 —
 1880 1879 1949 16, 1878—1886
 1875 1879 1949 16, VI, XII—XIII
 1897 1878 VII,
 1929—1935
 XIII
 XII—XIII 16, VIII, X 23/49; 12 — VIII A, XII —
 105; 10 —
 33/49; 7 — 41, 19; 6 —
 33/22; 9 — 10; 8 —
 59/9 10; 8 —
 VII, XI 1, X 431; 5 —
 XIII 431; 5 —

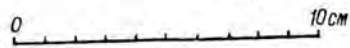
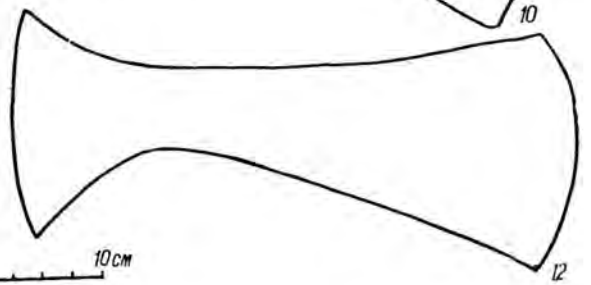
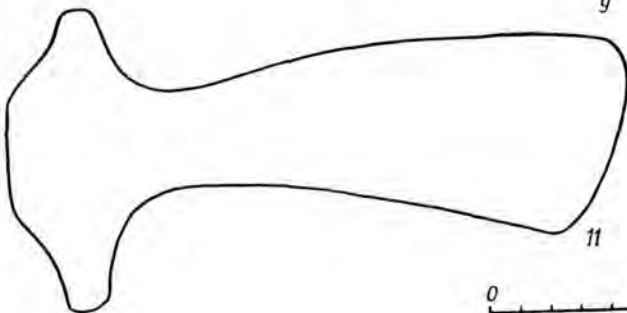
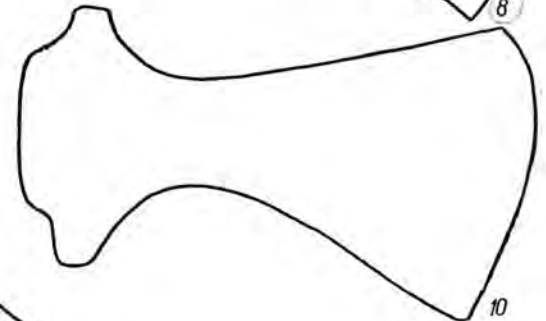
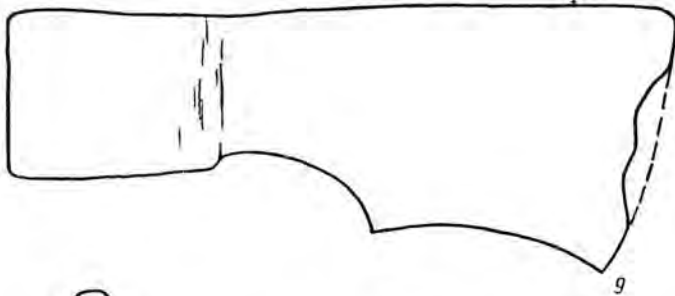
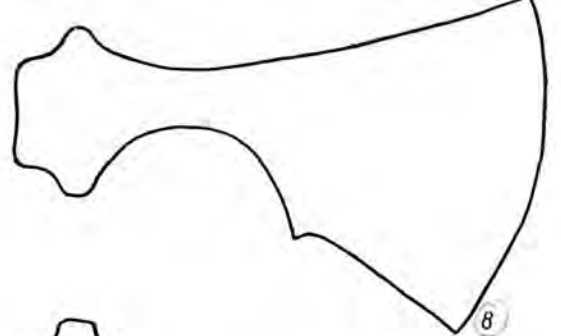
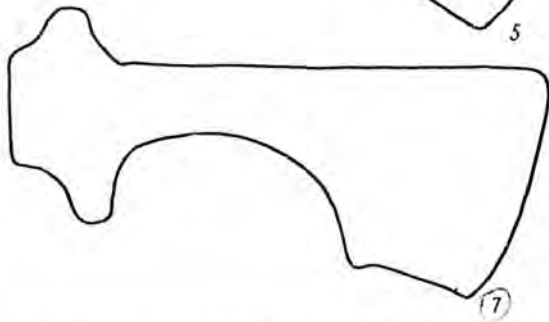
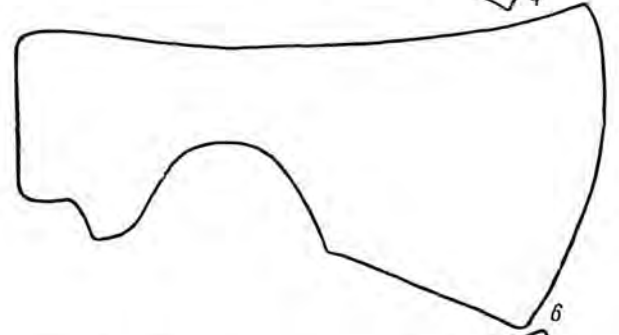
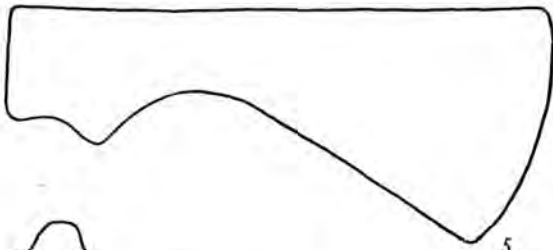
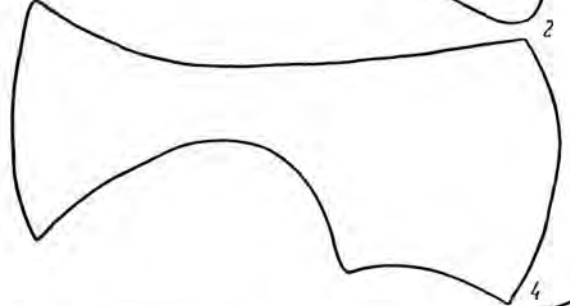
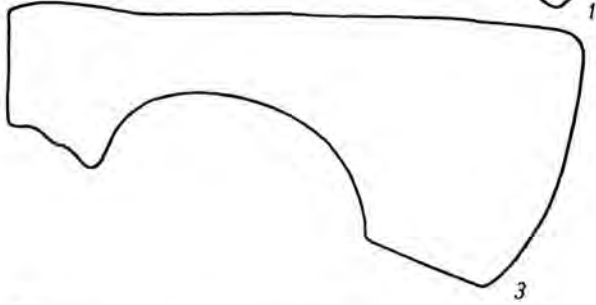
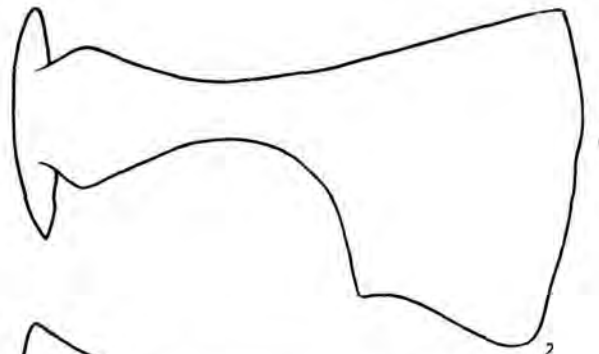
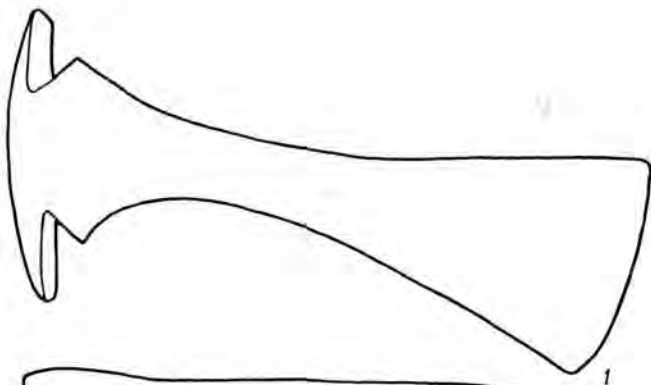



1



5



2



6



3



7

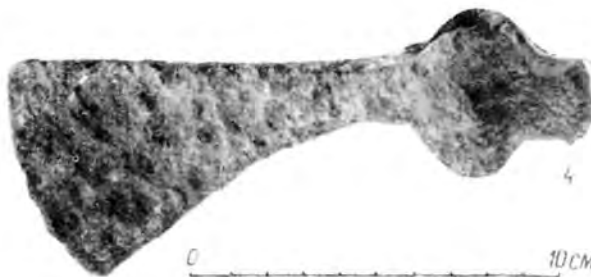

4



8

0 10CM

0 5CM

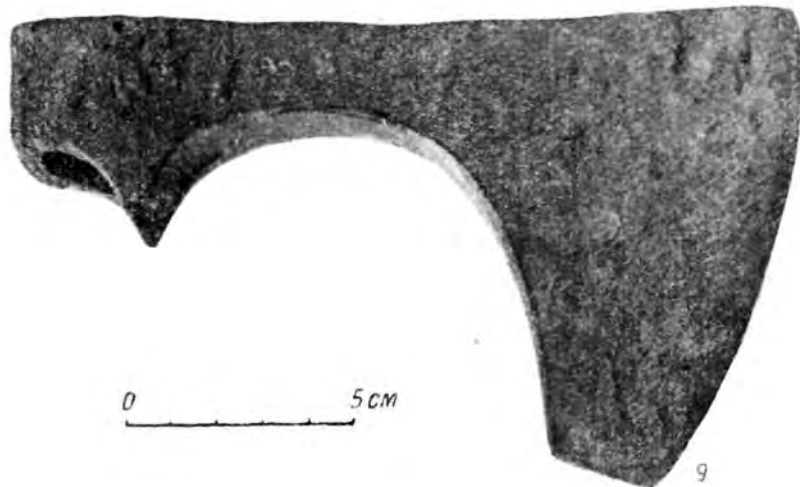

9

0 5CM

XVII.

X—XI

1 — (3); 2 — (33); 3, 4 — (75); 8 — V, (103); 9 — (8—9); 5 — (361);
6 — (392); 7 — 1878—1886 ., LX, 2, 41/28

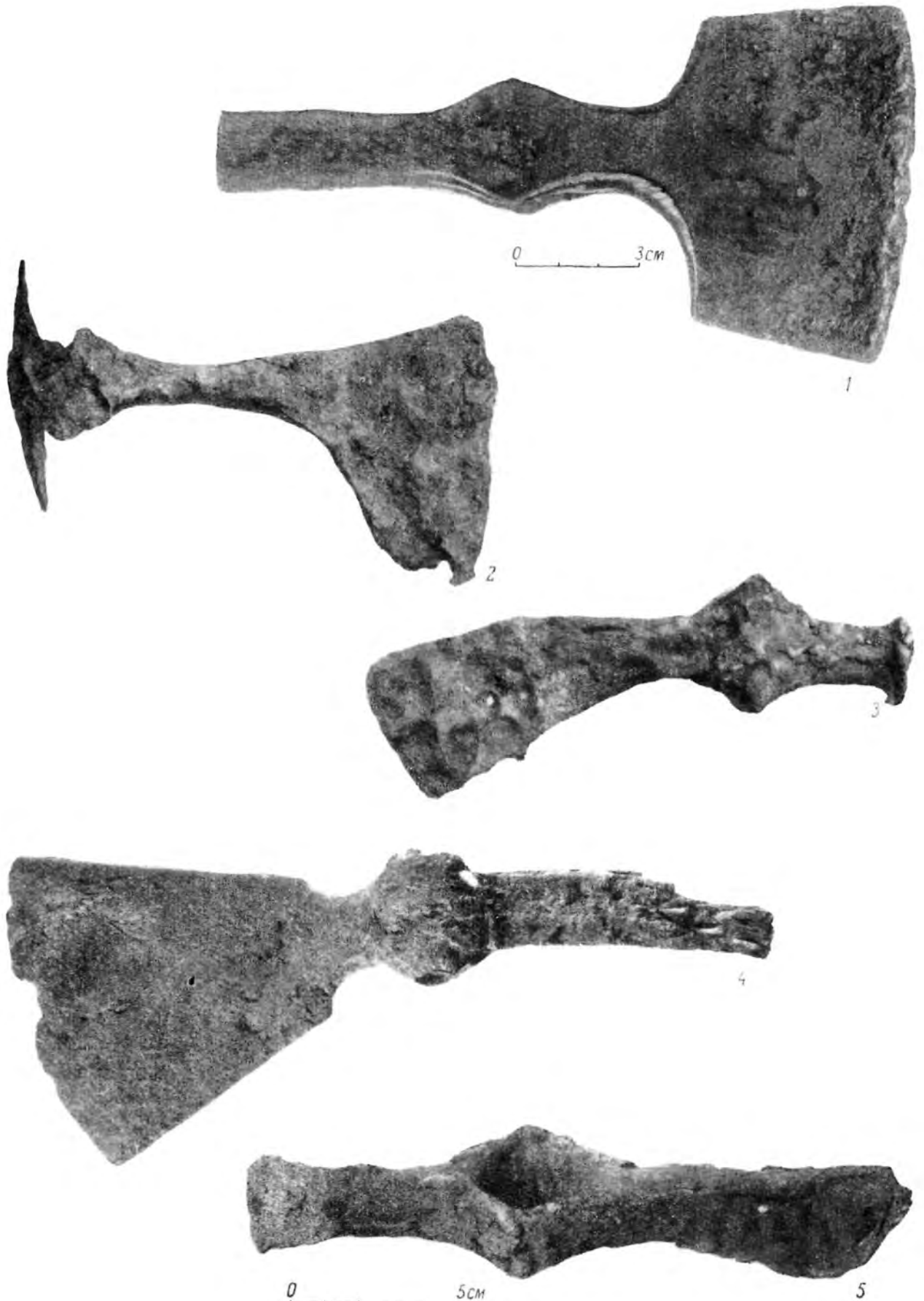

XVIII.

1 — (32); 2 — (315); 3 — (205); 4 — (54); 5 — (452).



0 ————— 3cm

2

XIX.



1



2



3



XX.

----- 1 ----- (58); 2 ----- (94); 3 ----- (488).



. XXI.

(1, 2, 8-13)

(5-7) - III .

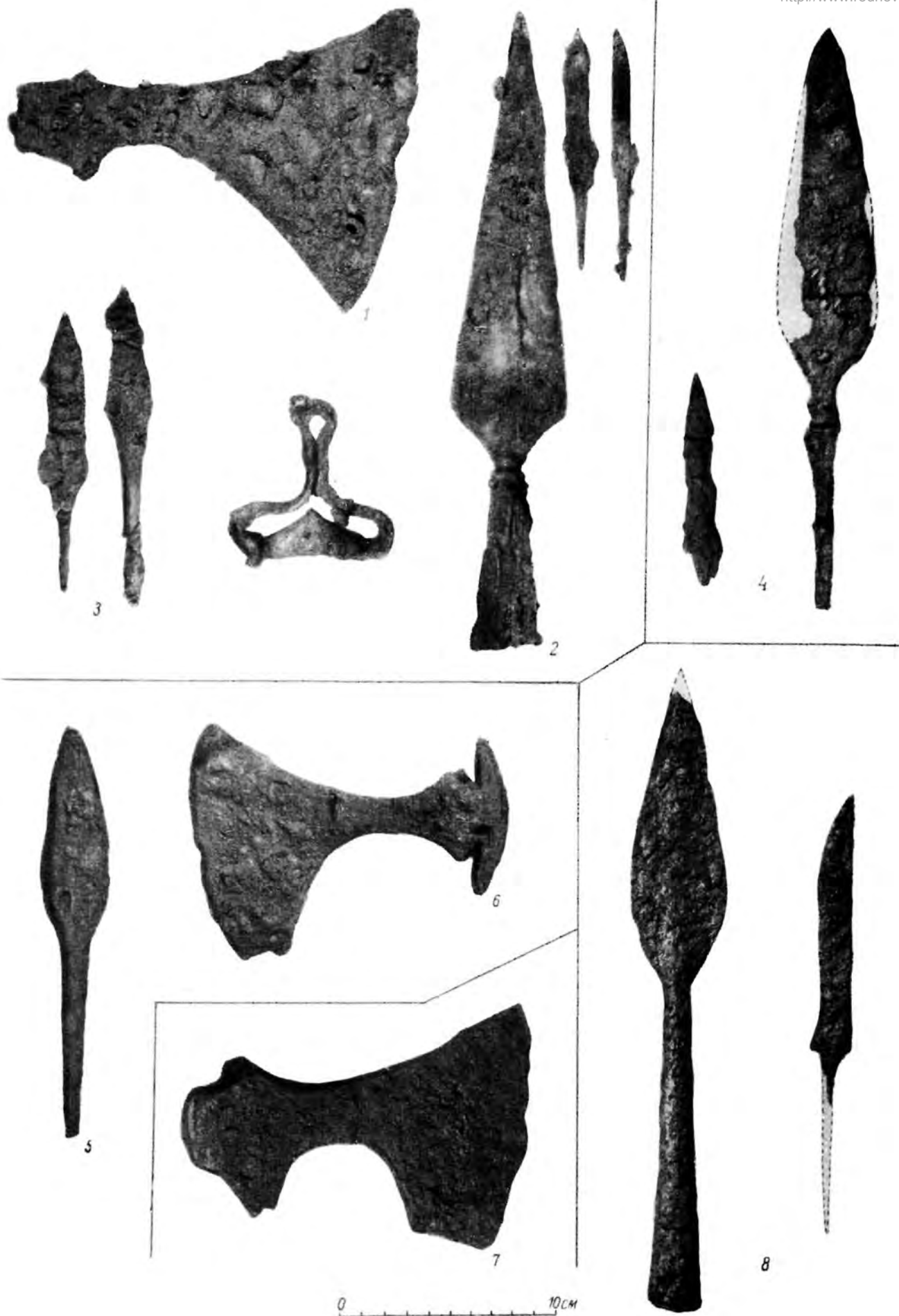

XXII. (178); 2 — (79); 3 — (256); 4 — (350); 5 — (19); 6 — (256); 7 — (399); 8 — (350); (1, 6, 7) (3) X—XII . () .

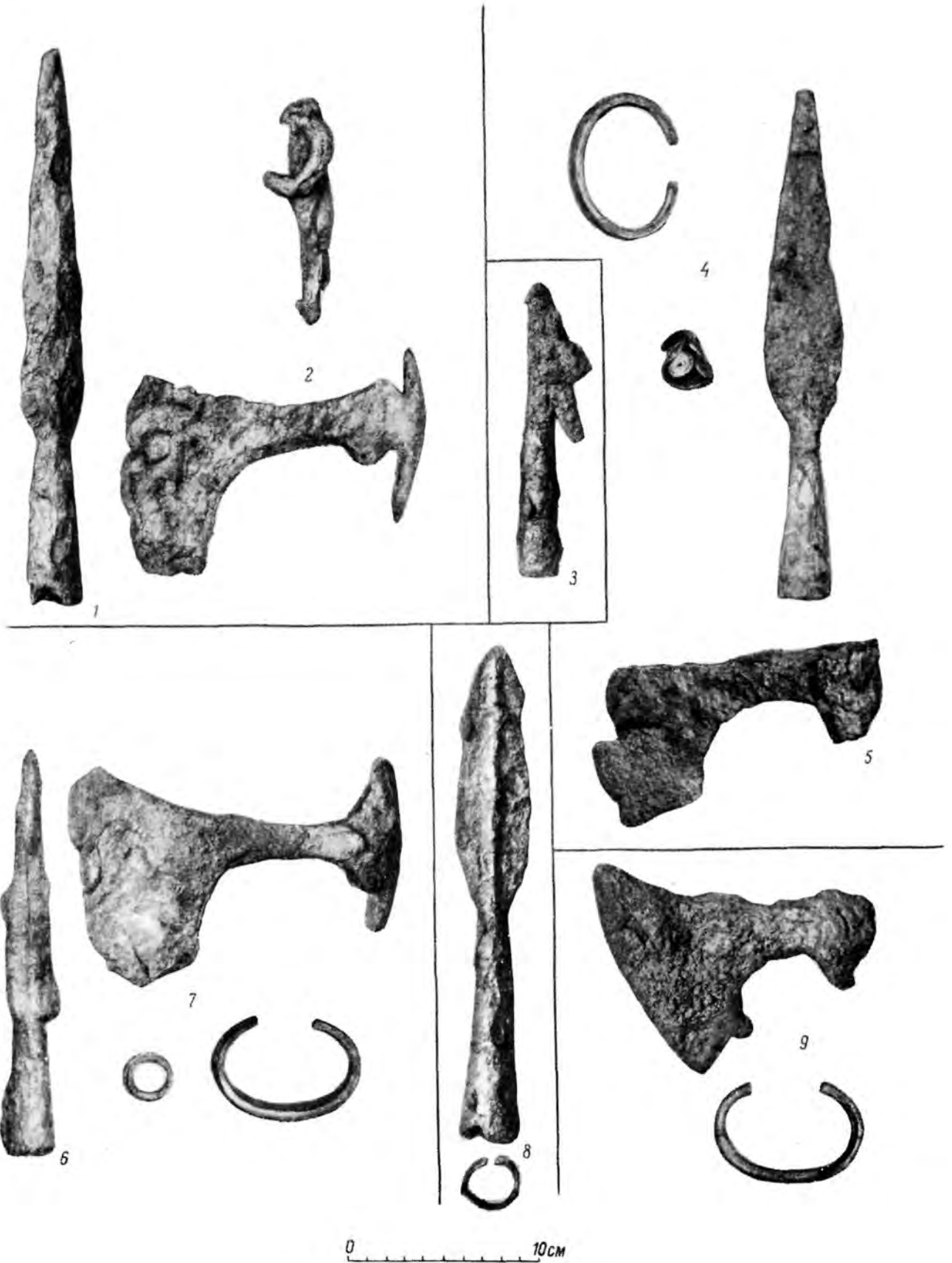

XXIII. (1, 3, 4, 6, 8), (5, 9) (2, 7) XI . ().
 1 — (316); 2 — (317); 3 — IV, XI ; 4 — (385); 5 — (351); 6 — (383); 7 — IV, XI ; 8 — (352); 9 — (400).

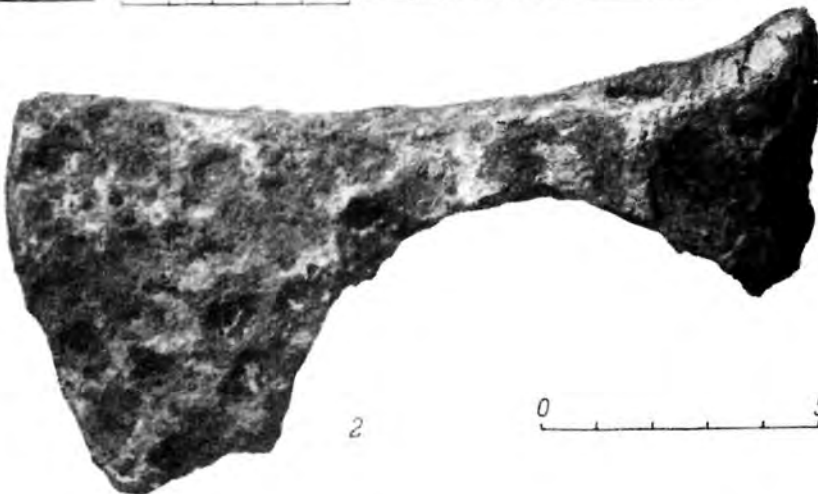

0 5cm

XXIV. (3) (1, 2) XI—XII . ()
 1 - (271); 2 — (473); 3 — (481).

XXV—XXVIII.

X—XIII

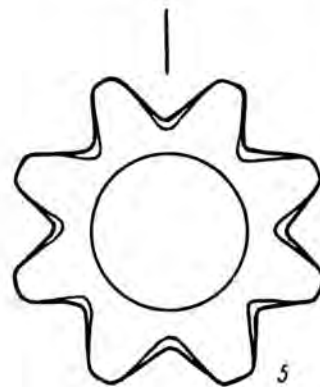
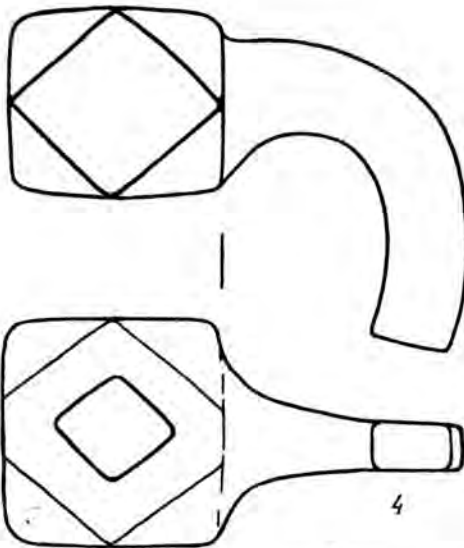
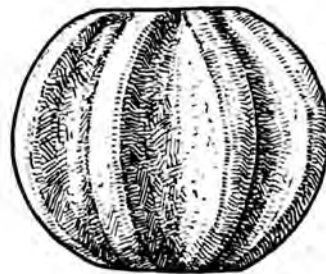
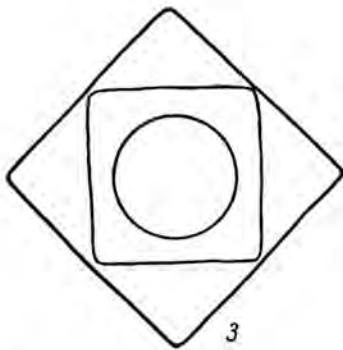
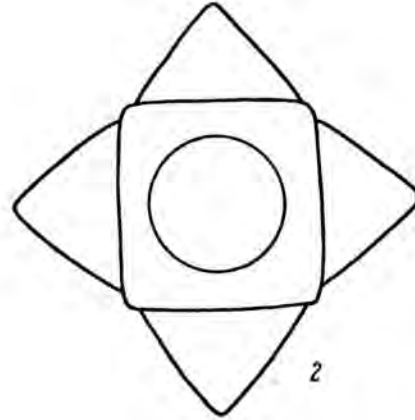
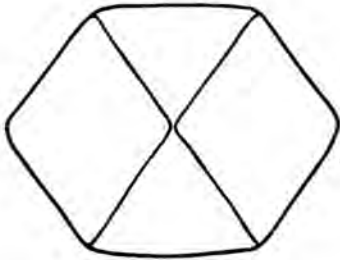
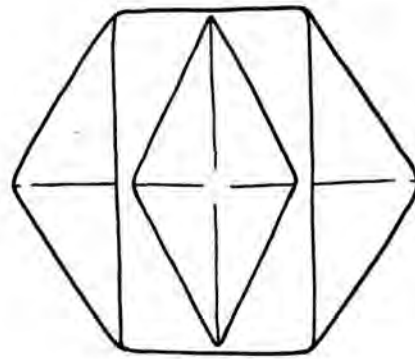
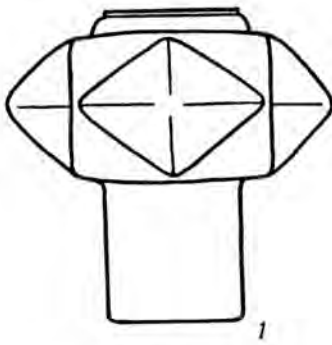

0 5cm

XXV.

1 — (1); 2 — (2); 3 — (10); 4 — (50); 5 — (87).



. XXVI.

1 — (54); — (56); 3 — , III, XII— III . (?); 4 — (80); 5 — , (3).

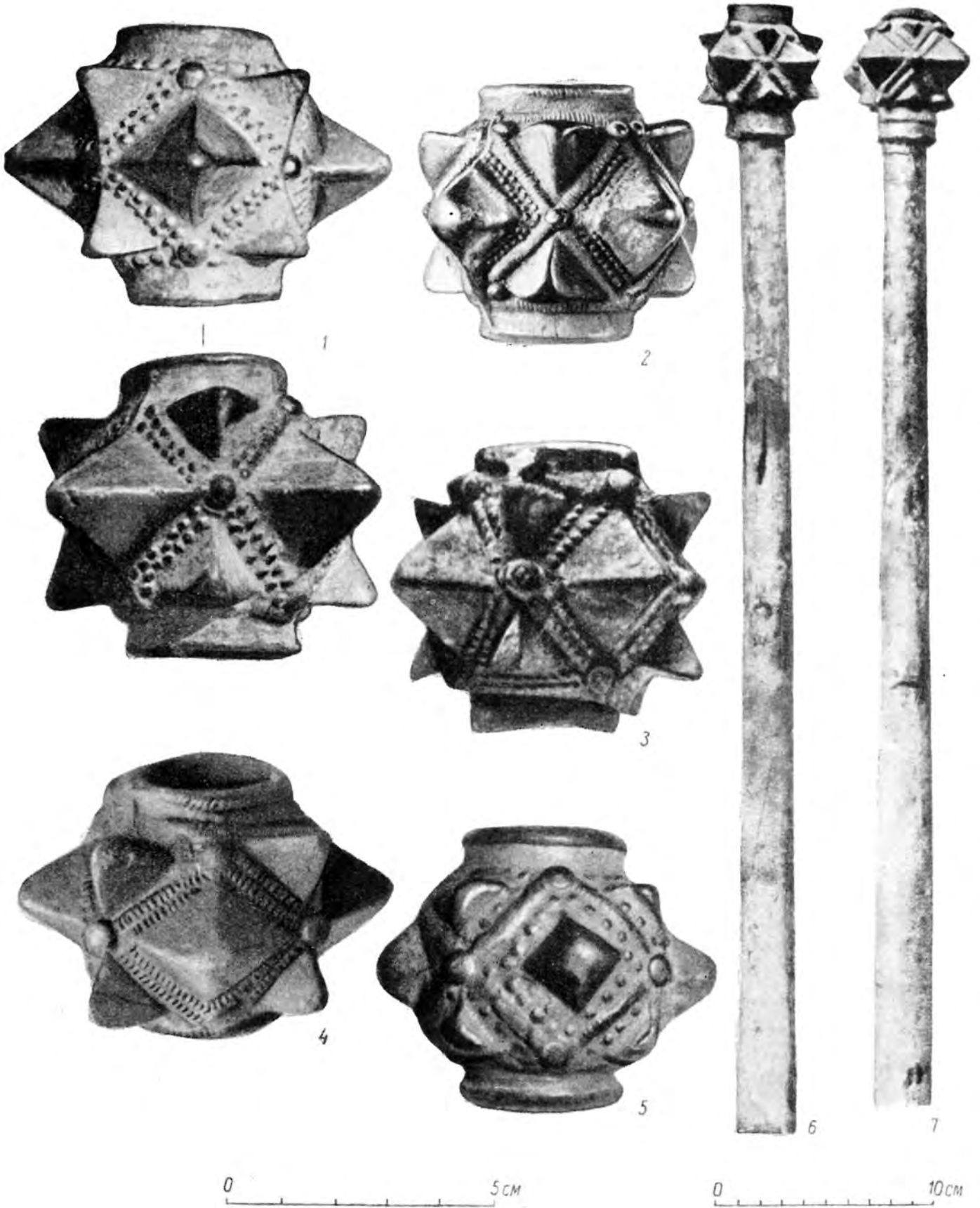

1 — (81); 2 — (63); 3 — (75); 5 — (76); 6, 7 — III, XII—XIII (61, 62).

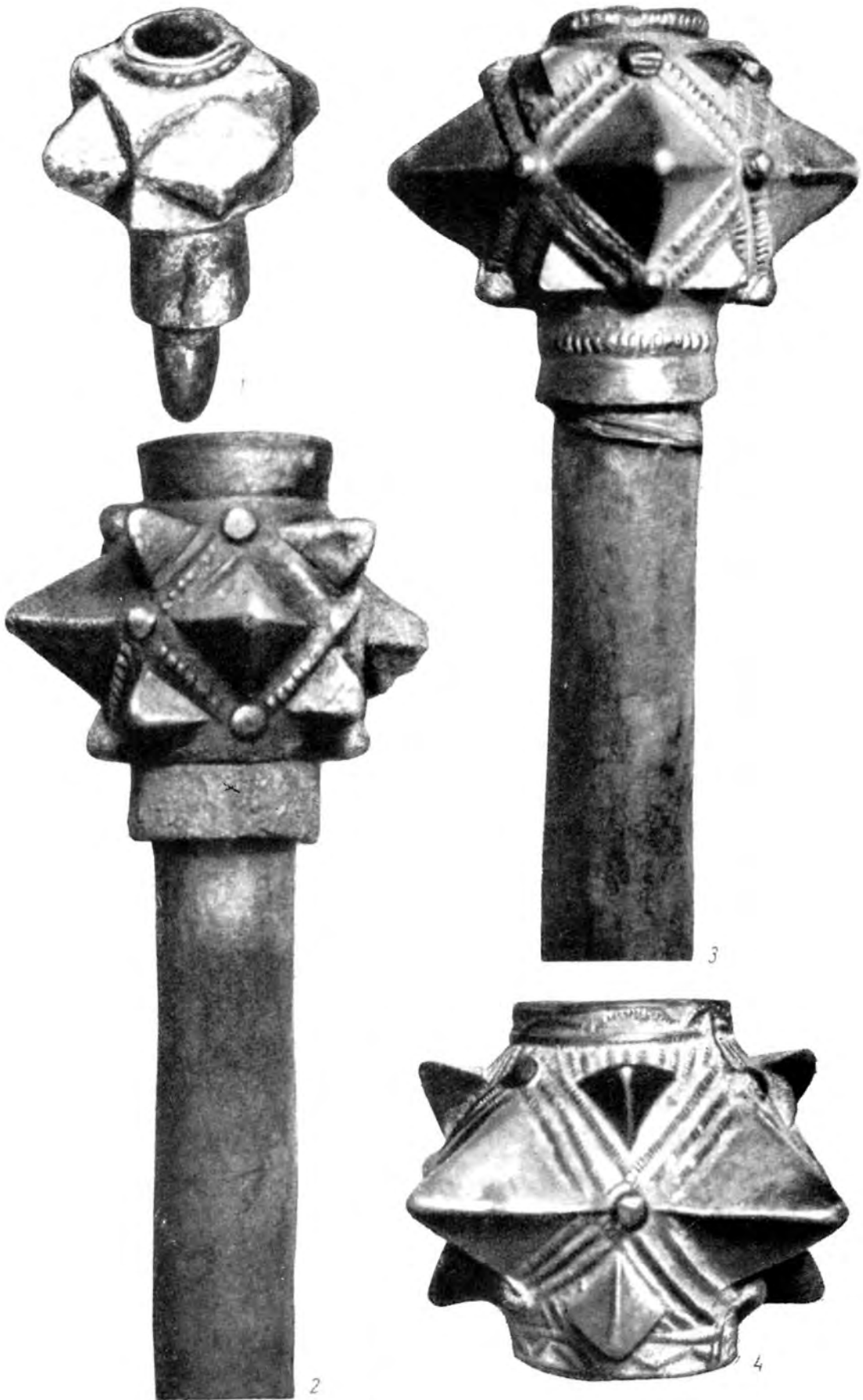

0 5cm

. XXVIII.

1 — (1); 2, 3 — (61, 62); 4 — (67).

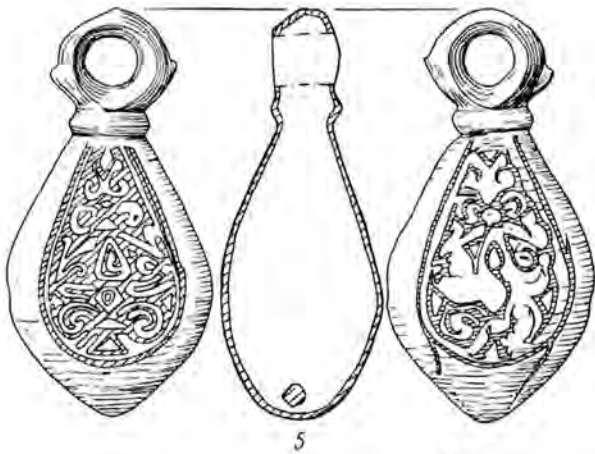
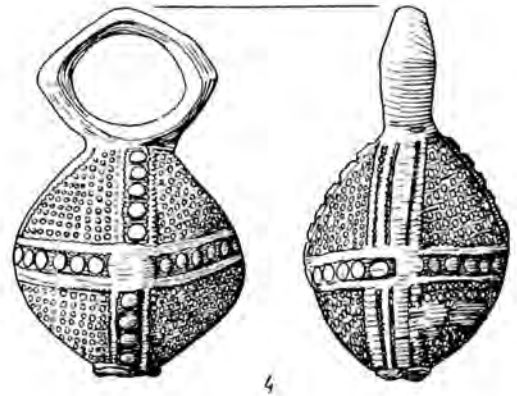
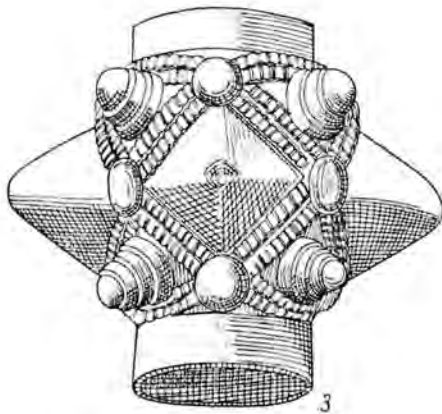
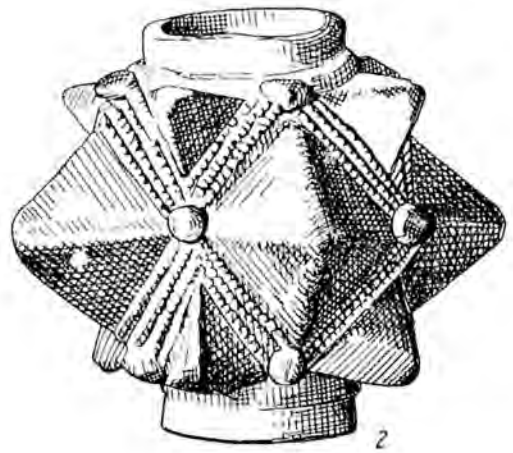
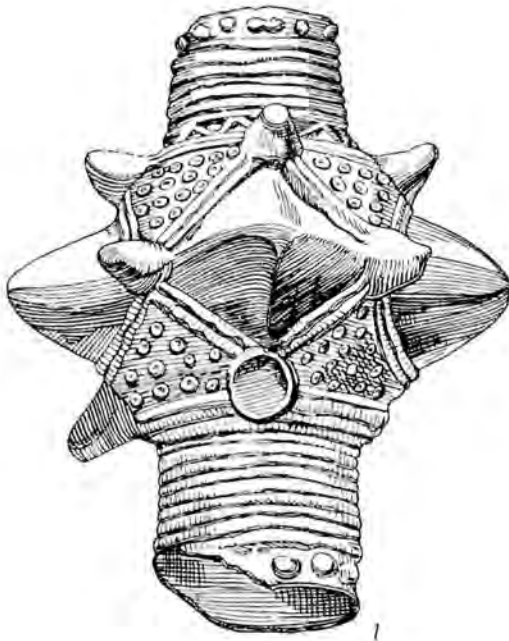

0 5cm

XXIX. (1-3) (4-6) XII-XIII .
1 - (58); 2 - IV, XII-XIII .; 3 - (51); 4 - (80);
5 - (99); - (120).

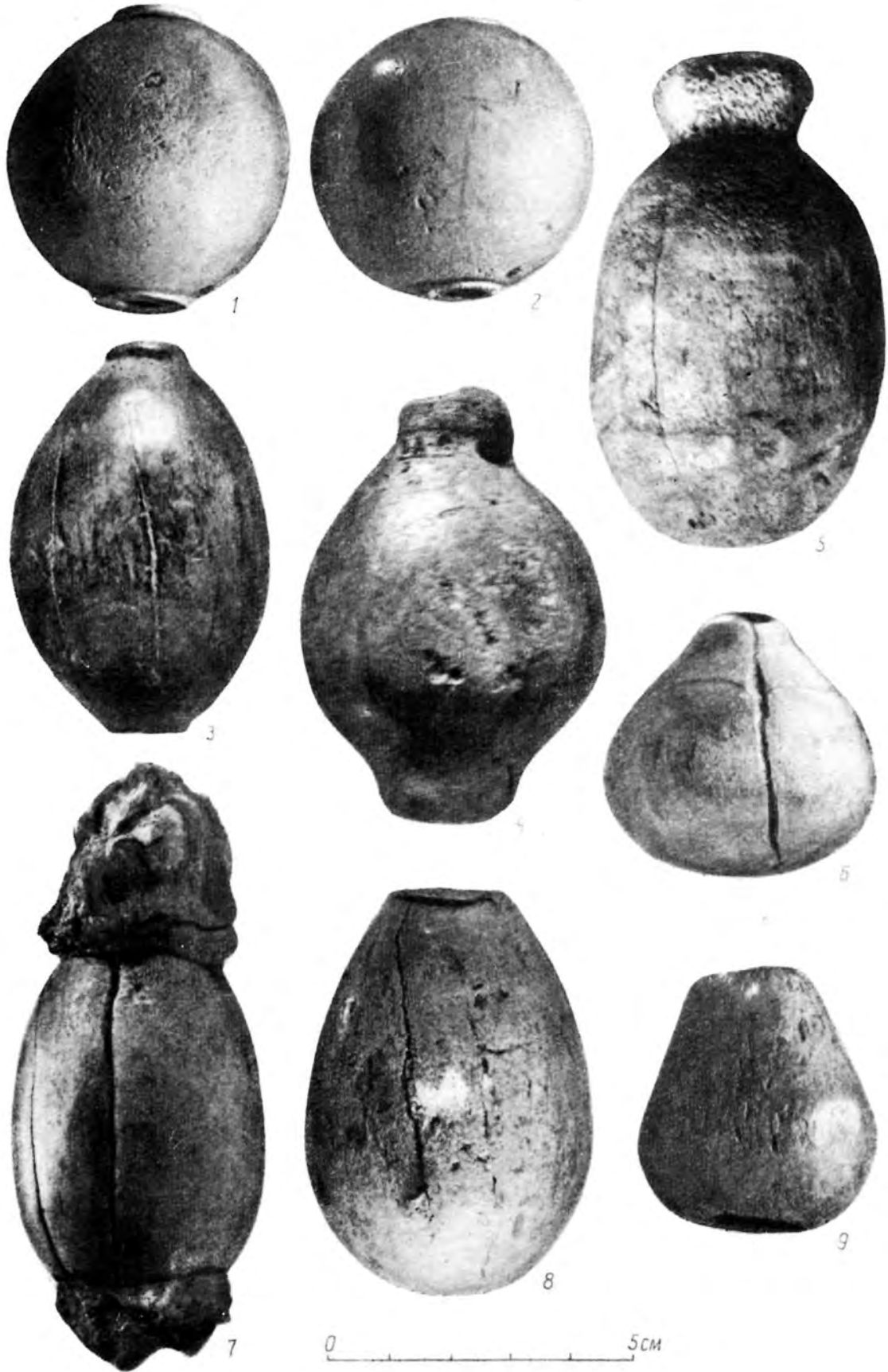

1-4, 6 —

XXX.

(20—24); 5 — (32—34).

(17); 7-9 —

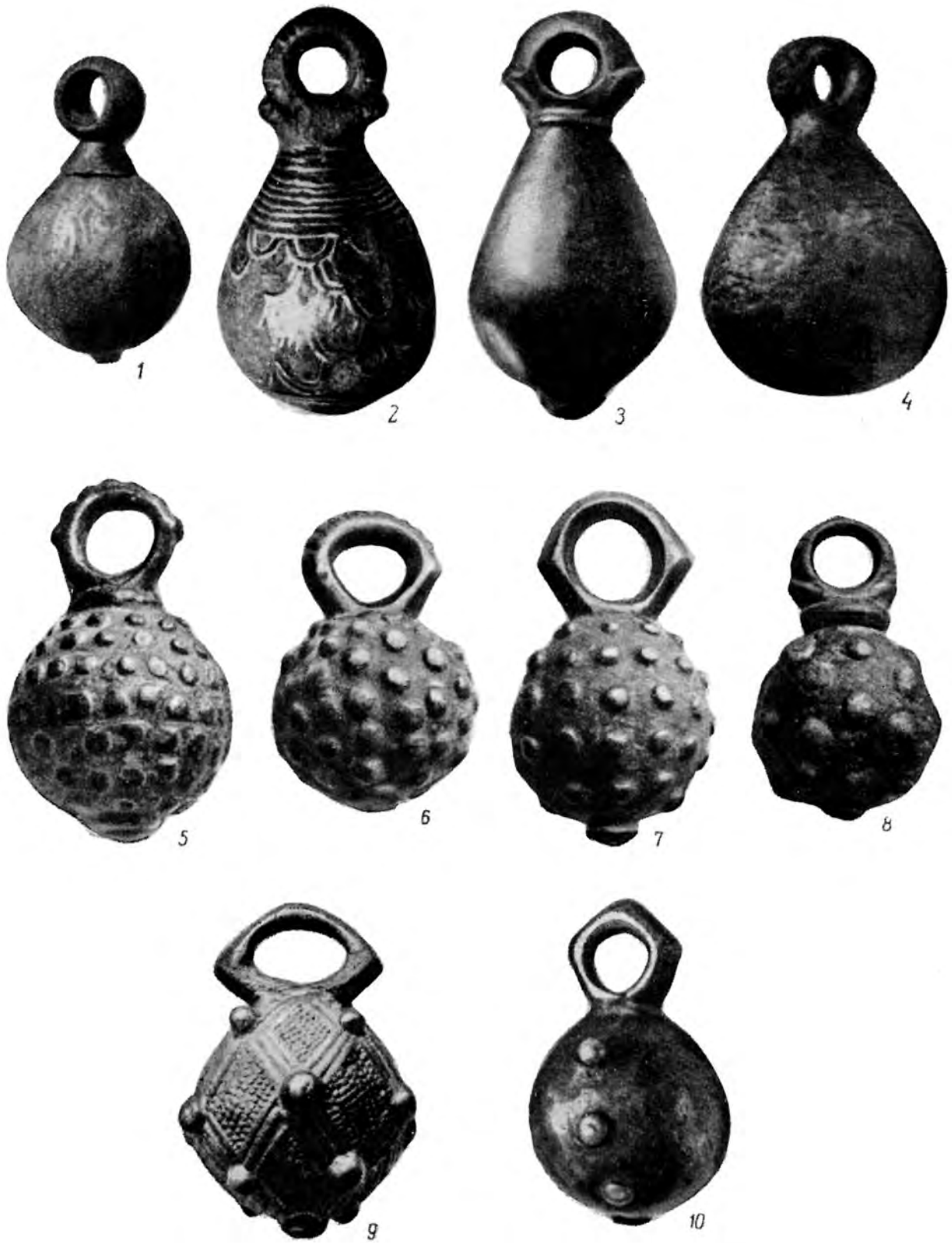

. XXXI.

1 — (50); 2 — (53); 3 — (43); 4 — (65); 5 — (74); 6—8 — (69—71); 9 — (72); 10 — (55);



0 5cm

. XXXII.

1886 .. II, XII⁽⁴⁷⁾ III² ; 5 : (75-77); 12 - (108); 6⁽⁴⁸⁾ ; 3, 4 - (68); 7 - ; .. II, XII-III⁽⁶⁹⁾ 8 - ; .. 1941 ..



XXXIII.

1 — (86); 2 — (116); 3 — (85); 4 — (91); 5 — (90); 6 — (88); 7 — (107); 8 — (118); 9 — (908/2); 10 — (119).

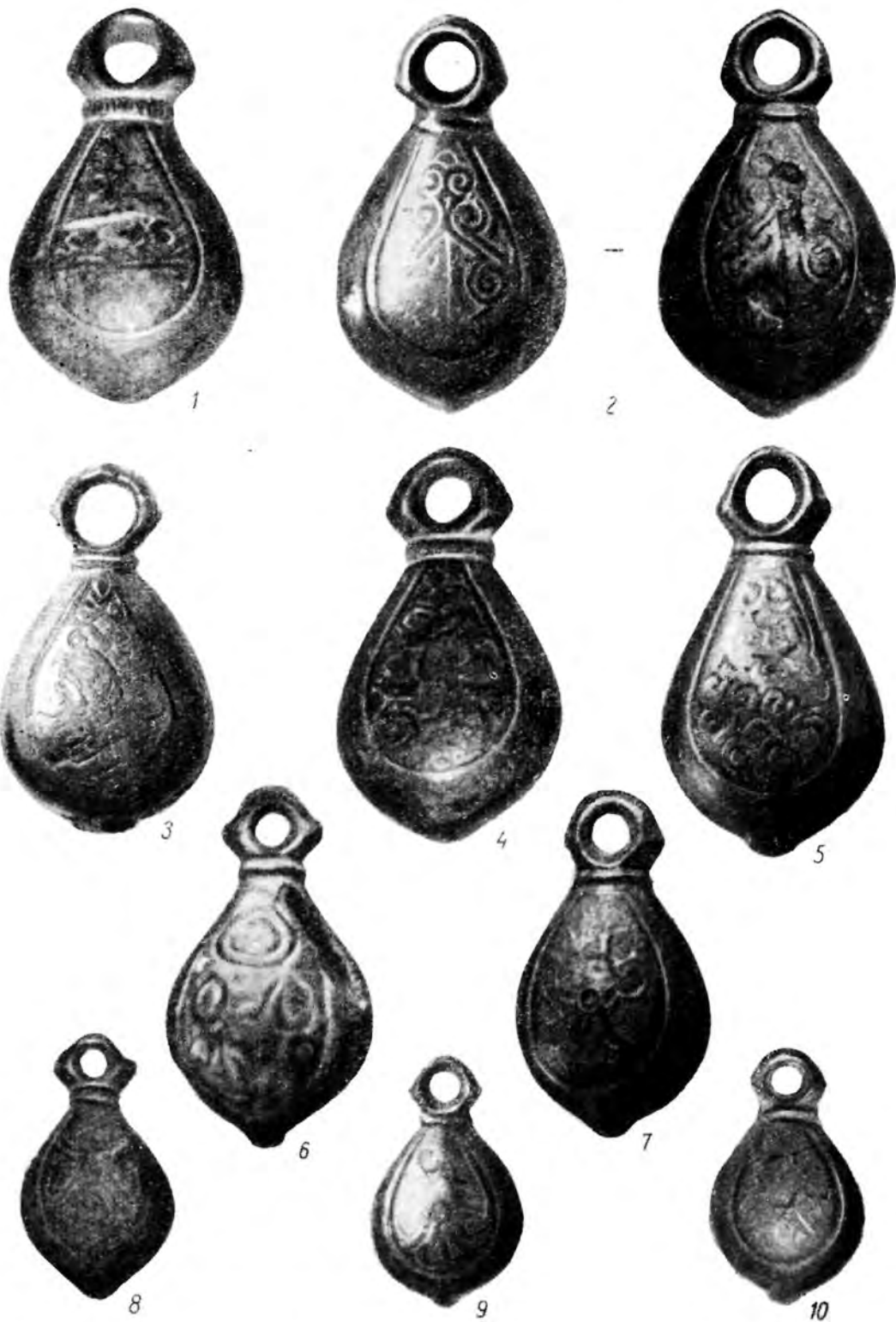

XXXIV.

1 - (84); 2 - (87); 3-5 - (92-94); 6-7 - (97-98);
 8-10 - XIII

	1.	5
2.		26
3.	(.....)	47
4.		58
		66
		68
		140
		143
		15-47.	147

. 2. , , , ,

.

15/I 1966 .

7/VI 1966 .

133—116 . 60 90 .

. . 13½. . 27 = 27 . .

. . - . . 22. . 2890. .

. 721. -06924. 1900.

1

I . 39 .

« »

, -164, ., . 1

1- . « ».

-34, 9 , . 12

